



IP over DWDM
OPTICAL LINE SYSTEM

CONTENTS

🌀 IP over DWDM	3
🌀 Key elements for optical layer deployment	3-4
🌀 Fiberroad Optical Line System	5
🌀 Attenuation solution – EDFA	6-8
🌀 Attenuation solution – SOA	9
🌀 Attenuation solution – Raman Amplifier	10
🌀 Dispersion solution – DCF	11
🌀 Dispersion solution – FBG-DCM	12
🌀 Dispersion solution – Tunable-DCM	13
🌀 OSNR Solution – OPM	14
🌀 Optical Line Protection	15
🌀 Optical Multiplexer – CWDM & DWDM	16-21

IPoDWDM simplify network architecture

'Internet Protocol (IP) over DWDM' is the concept of sending data packets over an optical layer using DWDM for its capacity and other operations. In the modern day world, the optical layer has been supplemented with more functionality, which were once in the higher layers. This creates a vision of an all-optical network where all management is carried out in the photonic layer. The optical network is proposed to provide end-to-end services completely in the optical domain, **without having to convert the signal to the electrical domain during transit**. Transmitting IP directly over DWDM has become a reality and is able to support bit-rates of **400Gbps**. As we can clearly see, it holds the key to the bandwidth glut and opens the frontier of terabit Internets too.

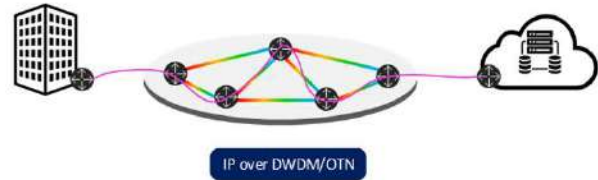
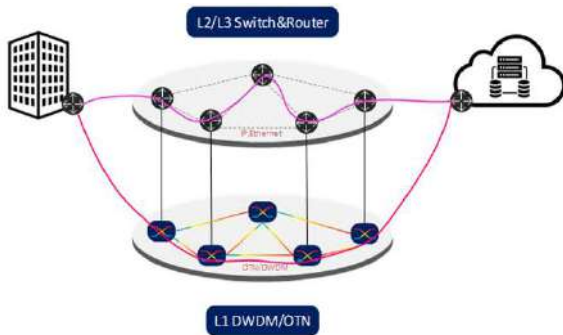

Key elements for optical line

Different Fiber Types for Different Applications

Types	Name	Features	Applications
G.651	Multi-mode progressive index fiber	Application wavelength as 850nm/1310nm	Mainly used in local area networks, not for long distance transmission
G.652	Dispersion-unshifted single mode fiber	The zero dispersion wavelength is about 1310nm	The most widely used optical fiber
G.653	Dispersion-shifted optical fiber	Dispersion be minimized at about 1550nm, thus minimizing optical loss	It is very suitable for long distance single channel optical communication system
G.654	Cut-off shifted optical fiber	1550nm has the lowest attenuation coefficient (15% less than G.652, G.653,G.655 fiber), so it is called low attenuation fiber, and the dispersion coefficient is the same as G.652 fiber	Mainly used for long distance transmission under the sea or on the ground
G.655	Non-zero dispersion-shifted fiber	The dispersion at 1550nm is close to zero, but not zero	Suitable for WDM and long distance optical cable
G.656	Low slope non-zero dispersion-shifted optical fiber	Attenuation is low between 1460nm and 1625nm, but is too low for a WDM system when the wavelength is less than 1530nm	It ensures the transmission performance in the broader wavelength range of DWDM system
G.657	Bending Insensitive optical fiber	The minimum bending radius is 5~10mm	Mainly used for FTTH access

Optical Signal-to-Noise Ratio (OSNR)

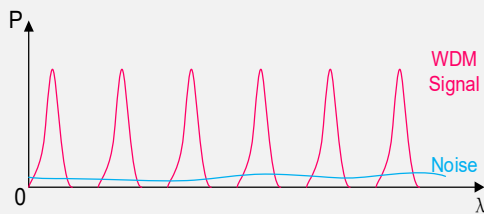

- OSNR is a measure of the ratio of signal level to the level of system noise
- As OSNR decreases, possible errors increase
- OSNR is measured in decibels (dB)
- EDFAs are the source of noise

Attenuation

- The attenuation of the optical fiber is a result of two factors, absorption and scattering.
- Additionally caused by passive media components, such as cables, cable splices, and connectors.

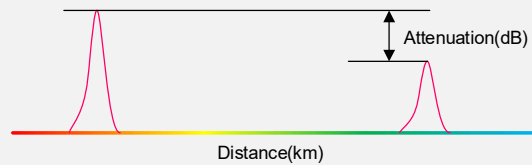

Dispersion

- Material Dispersion occurs because the speed of light varies at different wavelengths through glass
- Waveguide Dispersion caused because light is being transmitted in the fiber's mode-field diameter (MFD), which includes the fiber core and the inner part of the cladding.
- Even small amounts of glass ovality/non-concentricity or non-concentric stresses in the cable can cause one of the polarizations to travel faster than the other, spreading out in time as they travel along the fiber. This phenomenon is called polarization mode dispersion (PMD).

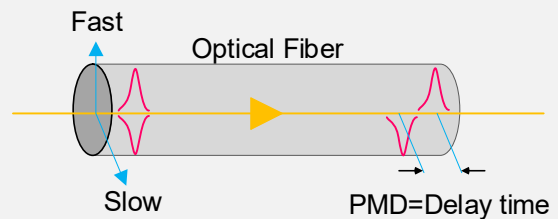
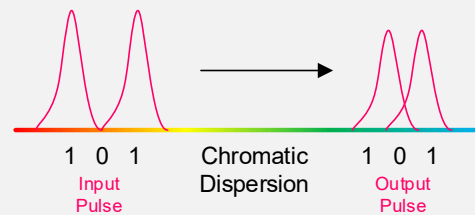

Non Linear Effects

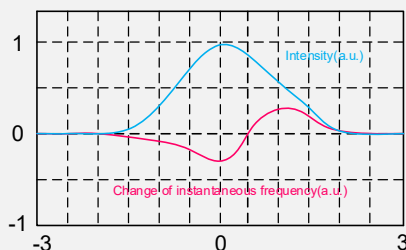
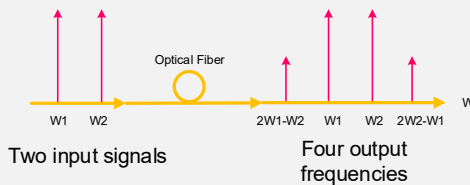

Polarization Mode Dispersion (PMD)

- Caused by Non Linearity of Fiber Geometry
- Effective for Higher Bit rates

Four Wave Mixing (FWM)

- Effects multi-channel systems
- Effects higher bit rates

Self/Cross Phase Modulation (SPM, XPM)

- Caused by high channel power
- Caused by channel interaction

Fiberroad

OPTICAL LINE SYSTEM



Open Structure
Pay as you need



Centralized Structure
Unified Management



Efficient network management

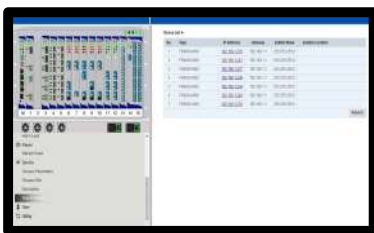

WEB-GUI



NMS

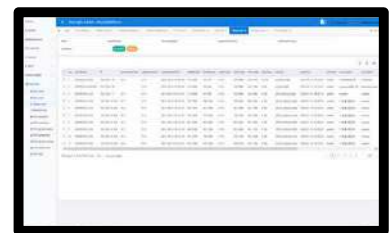

Cloud
(Coming soon)



Alarm Management

Support audio,Email/SMS,
Real time monitoring



Security

Linux operating system
SSH,SSL,SNMPv1,v2



Topology Discovery

E-map location, fault
location

Attenuation Solution

EDFA FR8000 Series

Overview



Open Structure



Centralized Structure

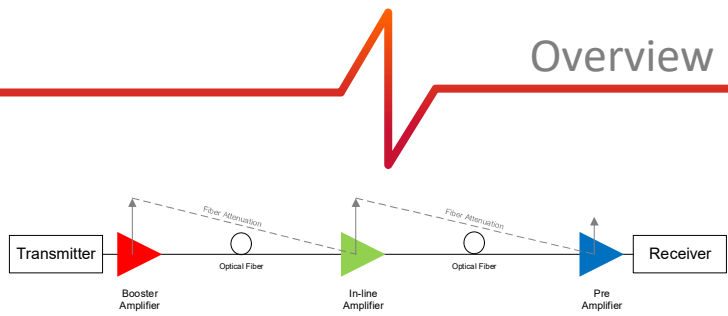

Figure 1

EDFAs are used as a booster, inline, and pre-amplifier in an optical transmission line, as schematically shown in Figure 1. The booster amplifier is placed just after the transmitter to increase the optical power launched to the transmission line. The inline amplifiers are placed in the transmission line, compensating the attenuation induced by the optical fiber. The pre-amplifier is placed just before the receiver, such that sufficient optical power is launched to the receiver. A typical distance between each of the EDFAs is several tens of kilometers.

Product Highlights

- ❖ Three Optical Amplifier C-Band applications:
 - Booster
 - In-line
 - Pre-amplifier
- ❖ Low noise figure: typ 5dB
- ❖ Gain flattening filters (GFF) assure flat Gain (<1 dB variance) over the entire amplified band (Wide-Band models only)
- ❖ Multiple operating modes:
 - AGC adjustable Gain ,
 - APC output is adjustable,
 - ACC voltage adjustable
- ❖ Transient response control: high performance transient response control to ensure power, Gain and stability, without affecting existing signal
- ❖ Customization
 - Support red and blue port, which used for single-fiber DWDM transmission systems.
- ❖ Midstage access:
 - Designed for insertion of a DCM unit without its inherent insertion loss.
 - Designed for insertion of a OADM unit without its inherent insertion loss
- ❖ Advanced network management features:
 - Optional OSC management channel for remote management
 - Support SNMP , Web console management



Figure 2
Modular Card

Network Management Interface



Slot	Description	Default
Threshold	When input power lower than threshold value, PUMP OFF When output power lower than threshold, EDFA trigger alarm	None
Eyesafe Mode		OFF
Working Mode	AGC: Adjustable Gain ± 1 dB APC: Output adjustable ± 1 dB ACC: Voltage adjustable	AGC
Pump information	Real-time indication	Read Only

Attenuation Solution

EDFA FR8000 Series

Specifications

Model	Description	Gain (dB)	Max.Output (dBm)	Min.Input (dBm)	Max.Input (dBm)	Typ.NF (dB)
Booster Amplifier						
BA16/G12	Booster, Max.Output 16dBm, Gain 12dB, With OSC	12dB	16dB	-10dBm	4dBm	5dB
BA16/G12NS	Booster, Max.Output 16dBm, Gain 12dB, Without OSC	12dB	16dB	-10dBm	4dBm	5dB
BA20/G12	Booster, Max.Output 20dBm, Gain 12dB, With OSC	12dB	20dB	-10dBm	8dBm	5dB
BA20/G12NS	Booster, Max.Output 20dBm, Gain 12dB, Without OSC	12dB	20dB	-10dBm	8dBm	5dB
Bi-Directional Booster Amplifier						
BA16/G12B	Bidi Booster, Max.Output 16dBm, Gain 12dB With OSC, Pass 1528~1543.2 (Blue) , Reflection 1547~1561nm (Red)	12dB	16dB	-10dBm	4dBm	5dB
BA16/G12NSB	BidiBooster, Max.Output 16dBm, Gain 12dB, Without OSC, Pass 1528~1543.2 (Blue) , Reflection 1547~1561nm (Red)	12dB	16dB	-10dBm	4dBm	5dB
BA20/G12B	BidiBooster, Max.Output 20dBm, Gain 12dB, With OSC, Pass 1528~1543.2 (Blue) , Reflection 1547~1561nm (Red)	12dB	20dB	-10dBm	8dBm	5dB
BA20/G12NSB	BidiBooster, Max.Output 20dBm, Gain 12dB, Without OSC, Pass 1528~1543.2 (Blue) , Reflection 1547~1561nm (Red)	12dB	20dB	-10dBm	8dBm	5dB
BA16/G12R	BidiBooster, Max.Output 16dBm, Gain 12dB, With OSC, Pass 1547~1561nm (Red) , Reflection 1528~1543.2 (Blue)	12dB	16dB	-10dBm	4dBm	5dB
BA16/G12NSR	BidiBooster, Max.Output 16dBm, Gain 12dB, Without OSC, Pass 1547~1561nm (Red) , Reflection 1528~1543.2 (Blue)	12dB	16dB	-10dBm	4dBm	5dB
BA20/G12R	BidiBooster, Max.Output 20dBm, Gain 12dB, With OSC, Pass 1547~1561nm (Red) , Reflection 1528~1543.2 (Blue)	12dB	20dB	-10dBm	8dBm	5dB
BA20/G12NSR	BidiBooster, Max.Output 20dBm, Gain 12dB, Without OSC, Pass 1547~1561nm (Red) , Reflection 1528~1543.2 (Blue)	12dB	20dB	-10dBm	8dBm	5dB
Pre-amplifier						
PA16/G20	Pre-amplifier, Max.Output 16dBm, Gain 20dB, With OSC	20dB	16dB	-29dBm	-4dBm	4.5dB
PA16/G20NS	Pre-amplifier, Max.Output 16dBm, Gain 20dB, Without OSC	20dB	16dB	-29dBm	-4dBm	4.5dB
PA16/G20-8	Midstage accessPre-amplifier, Max.Output 16dBm, Gain 20dB, With OSC, Midstage insertion loss 8dB	20dB	16dB	-29dBm	-4dBm	5dB
PA16/G20NS-8	Midstage access Pre-amplifier, Max.Output 16dBm, Gain 20dB, With OSC, Midstage insertion loss 8dB	20dB	16dB	-29dBm	-4dBm	5dB
PA16/G25	Pre-amplifier, Max.Output 16dBm, Gain 25dB, With OSC	25dB	16dB	-30dBm	-9dBm	4.5dB
PA16/G25NS	Pre-amplifier, Max.Output 16dBm, Gain 25dB, Without OSC	25dB	16dB	-30dBm	-9dBm	4.5dB
PA16/G25-8	Pre-amplifier, Max.Output 16dBm, Gain 25dB, With OSC, Midstage insertion loss 8dB	25dB	16dB	-30dBm	-9dBm	5dB
PA16/G25NS-8	Pre-amplifier, Max.Output 16dBm, Gain 25dB, With OSC, Midstage insertion loss 8dB	25dB	16dB	-30dBm	-9dBm	5dB
PA20/G25	Pre-amplifier, Max.Output 20dBm, Gain 25dB, With OSC	25dB	20dB	-30dBm	-5dBm	5dB
PA16/G25-8	Pre-amplifier, Max.Output 16dBm, Gain 25dB, With OSC, Midstage insertion loss 8dB	25dB	16dB	-30dBm	-9dBm	6dB

Attenuation Solution

EDFA FR8000 Series

Specifications

Model	Description	Gain (dB)	Max.Output (dBm)	Min.Input (dBm)	Max.Input (dBm)	Typ.NF (dB)
In-Line-Amp						
LA16/G20	In-Line-Amp, Max.Output 16dBm, Gain 20dB, With OSC	20dB	16dB	-29dBm	-4dBm	5dB
LA16/G20NS	In-Line-Amp, Max.Output 16dBm, Gain 20dB, Without OSC	20dB	16dB	-29dBm	-4dBm	5dB
LA16/G20-8	Midstage accessIn-Line-Amp, Max.Output 16dBm, Gain 20dB, With OSC, Midstage insertion loss 8dB	20dB	16dB	-29dBm	-4dBm	6dB
LA16/G20NS-8	Midstage accessIn-Line-Amp, Max.Output 16dBm, Gain 20dB, Without OSC, Midstage insertion loss 8dB	20dB	16dB	-29dBm	-4dBm	6dB
LA20/G20	In-Line-Amp, Max.Output 20dBm, Gain 20dB, With OSC	20dB	20dB	-25dBm	0dBm	5dB
LA20/G20NS	In-Line-Amp, Max.Output 20dBm, Gain 20dB, Without OSC	20dB	20dB	-25dBm	0dBm	5dB
LA20/G20-8	Midstage accessIn-Line-Amp, Max.Output 20dBm, Gain 20dB, With OSC, Midstage insertion loss 8dB	20dB	20dB	-25dBm	0dBm	6dB
LA20/G20NS-8	Midstage accessIn-Line-Amp, Max.Output 20dBm, Gain 20dB, Without OSC, Midstage insertion loss 8dB	20dB	20dB	-25dBm	0dBm	6dB
LA16/G25	In-Line-Amp, Max.Output 16dBm, Gain 25dB, With OSC	25dB	16dB	-30dBm	-9dBm	5dB
LA16/G25NS	In-Line-Amp, Max.Output 16dBm, Gain 25dB, Without OSC	25dB	16dB	-30dBm	-9dBm	5dB
LA16/G25-8	Midstage accessIn-Line-Amp, Max.Output 16dBm, Gain 25dB, With OSC, Midstage insertion loss 8dB	25dB	16dB	-30dBm	-9dBm	6dB
LA16/G25NS-8	Midstage accessIn-Line-Amp, Max.Output 16dBm, Gain 25dB, Without OSC, Midstage insertion loss 8dB	25dB	16dB	-30dBm	-9dBm	6dB
LA20/G25	In-Line-Amp, Max.Output 20dBm, Gain 25dB, With OSC	25dB	20dB	-30dBm	-5dBm	5dB
LA20/G25NS	In-Line-Amp, Max.Output 20dBm, Gain 25dB, Without OSC	25dB	20dB	-30dBm	-5dBm	5dB
LA20/G25-8	Midstage accessIn-Line-Amp, Max.Output 20dBm, Gain 25dB, With OSC, Midstage insertion loss 8dB	25dB	20dB	-30dBm	-5dBm	6dB
LA20/G25NS-8	Midstage accessIn-Line-Amp, Max.Output 20dBm, Gain 25dB, Without OSC, Midstage insertion loss 8dB	25dB	20dB	-30dBm	-5dBm	6dB
LA20/G25-8-BR	Midstage accessIn-Line-Amp, Max.Output 20dBm, Gain 25dB, With OSC, Midstage insertion loss 8Db, with Blue/Red light	25dB	20dB	-30dBm	-5dBm	6dB
LA20/G25-8-RB	Midstage accessIn-Line-Amp, Max.Output 20dBm, Gain 25dB, With OSC, Midstage insertion loss 8Db, with Red/Blue light	25dB	20dB	-30dBm	-5dBm	6dB

Attenuation Solution

SOA Amplifier

Specifications

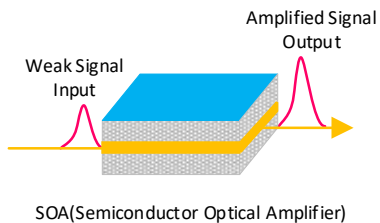

Figure 1

An SOA (Semiconductor Optical Amplifier) is a semiconductor element that amplifies light. Antireflective processing is applied on both facets of a semiconductor laser to eliminate the resonator structure. When light enters from outside the semiconductor, the light is amplified by stimulated emission.

SOA is used for amplifying an optical signal. SOAs are included in the optical transceiver modules used for communication between data centers to amplify the optical signal in the 1.3 um band used for Ethernet communication in order to compensate for transmission loss.

Product Highlights

- ❖ Support O-band, 1260 – 1340nm band amplification
- ❖ The output power can reach up to 13dBm
- ❖ Support three working modes, ACC,APC and AGC
- ❖ State monitoring or control via CLI, WEB, SNMP
- ❖ Support 19" 1U, 1.25U,2.5U chassis



Figure 2

FR8000-SOA Modular Card(Dual Channel)

Specifications

Parameter	Condition	Min	Typ	Max	Unit
Wavelength Range	40GE	1260		1340	nm
	100GE	1290		1320	nm
Input Power		-20		-10	dBm
Saturated Output Power			8	11	dBm
Gain			16		dB
Flatness				2	dB
Noise				7.5	dB
Polarization Dependent Gain				2	dB
Operating Temperature		-5		55	°C
Operating Humidity		5		95	%
Storage Temperature		-40		85	°C
Voltage		220VAC,-48VDC			V
Power Consumption	SOA	20			W
Dimensions	Single card	26.5 (W) × 195 (H) × 252 (D)			mm
	1 slot	482.6 (W) × 44.5 (H) × 320 (D)			1U
	8 slots	482.6 (W) × 111 (H) × 360 (D)			2.5U
Connector		LC/SC			

Attenuation Solution

Raman Amplifier

Specifications

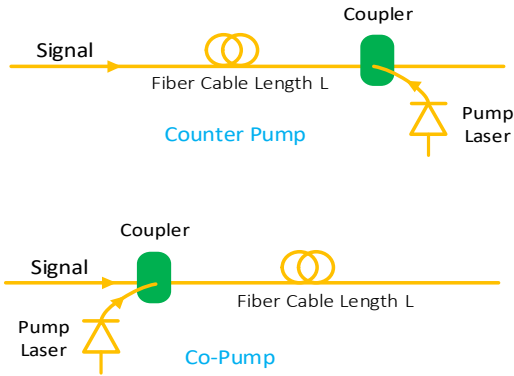

Figure 1 :Functional Principle of RAMAN

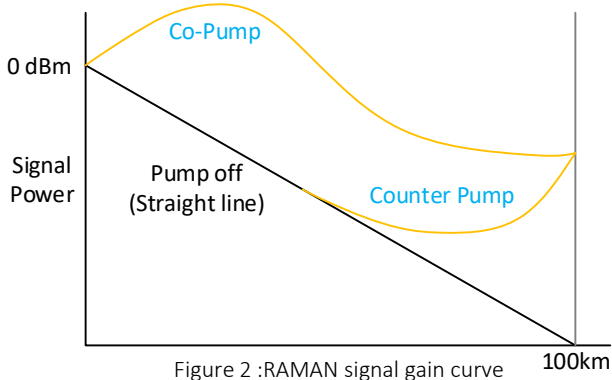

Figure 2 :RAMAN signal gain curve

A Raman-Amplifier uses the effect of Raman scattering. For this purpose, light with high power and a corresponding wavelength is pumped into the fiber. Amplification is performed if the incoming wavelength lies within the Raman gain spectrum.

Advantages of Raman Amplifiers

- Ultra-wideband amplifiers: The gain wavelengths of Raman amplifiers depend on pump light wavelengths. Theoretically, optical signals of any wavelength can be amplified when the pump light wavelength is proper.
- Low noise figure: The Raman amplifier and EDFA can be used together to effectively reduce the total noise of the system, improve the system OSNR, and extend the unregenerated transmission distance and the total transmission distance.
- Wide application: The gain medium of a Raman amplifier is the transmission fiber itself. The amplification is distributed along the fiber instead of being centralized. The optical power of signals in the fiber is low. Therefore, the interference of non-linear effects, especially the four-wave mixing (FWM) effects, can be reduced. In this way, long-haul unregenerated transmission and remote pumping can be achieved. This solution is especially applicable to scenarios where regeneration sites are difficult to be deployed, such as seabeds and deserts.

Disadvantages of Raman Amplifiers

- Low gain: Generally, the gain of an Raman fiber amplifier (RFA) is less than 15 dB. Therefore, an RFA needs to work with an EDFA.
- High pump optical power: Be cautious of security risks during delivery.
- High requirements on fiber quality and difficult delivery

Product Highlights

- ❖ Distributed low-noise amplification
- ❖ Support 19" 1U, 1.25U,2.5U chassis
- ❖ Easy control and operate
- ❖ High stability and reliability : MTBF > 150000
- ❖ State monitoring or control via CLI, WEB, SNMP
- ❖ Single channel , DWDM or C+L band is available
- ❖ Intelligent temperature control system: power consumption and hot radiation reduct 30% than general products
- ❖ Pump polarization independent design

Specifications

Parameters	Min	Typ	Max	Unit
Operating wavelength	1525	1550	1565	nm
Pump wavelength	1425	\	1505	nm
Pump output power	650	500	1400	mW
Operating Input Power range	-40	-1.5	10	dB
ON/OFF Gain range	6	\	20	dB
Gain Flatness	\	1	1.5	dB
Polarization Dependent Gain	\	\	0.3	dB
PMD	\	\	0.3	dB
Effective Noise Figure	\	-2	0	dB



Figure 3
FR8000-RFA
10

Dispersion Solution

Dispersion compensator

Specifications

Dispersion-Compensating Fiber(DCF)

Since dispersion is inevitable in optical fibers, dispersion-compensating fibers, such as those sold on this page, can be incorporated into optical systems. The overall dispersion of these fibers is opposite in sign and much larger in magnitude than that of standard fiber, so they can be used to cancel out or compensate the dispersion of a standard single-mode fiber, such as a nonzero dispersion-shifted fiber. A negative dispersion slope enables effective cancellation of dispersion over a larger wavelength range, since the dispersion slope of standard fiber is usually positive. Generally, a short length of dispersion-compensating fiber is spliced into a longer length of standard fiber to compensate for dispersion, as in the example below

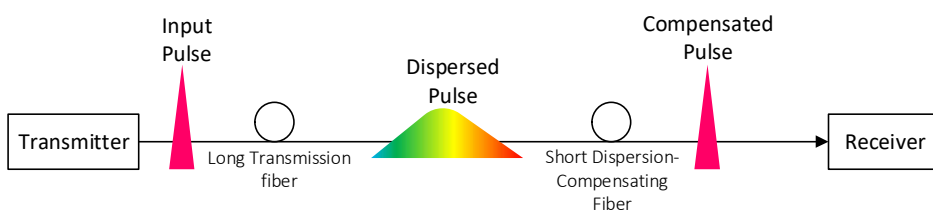

Figure 2
FR-DCM-XX

Product Highlights

- ❖ DWDM system dispersion compensation and broadband low residual dispersion
- ❖ G.652 fiber C-band 100% slope compensation (standard value)
- ❖ Low insertion loss
- ❖ Low polarization mode dispersion
- ❖ Performance indicators by
- ❖ Telcordia GR-2854-CORE standard certification
- ❖ Reliability by Telcordia GR-1221-CORE standard certification

Specifications

Parameters	DCM-20	DCM-40	DCM-60	DCM-80	DCM-100	DCM-120
Compensated Distance (km)	20	40	60	80	100	120
1545nm dispersion (ps/nm)	-340+/-10	-670+/-20	-1000+/-30	-1340+/-40	-1680+/-50	-2010+/-60
1545nm relative dispersion slope (nm ⁻¹)	0.0036 +/- 10%					
Insertion Loss (dB)	≤3.3	≤4.7	≤6.4	≤8.0	≤9.5	≤11.0
Insertion Loss (typ) (dB)	2.7	4.0	5.4	6.7	8.0	9.3
Polarization mode dispersion (ps)	≤0.6	≤0.7	≤0.8	≤0.9	≤1.0	≤1.1
Polarization mode dispersion (typ) (ps)	0.2	0.3	0.4	0.5	0.6	0.7
Polarization dependent loss (dB)	≤0.1	≤0.1	≤0.1	≤0.1	≤0.1	≤0.1
Parameters	MIN		MAX		UNIT	NOTES
Brillouin Scattering Threshold	6		-		dBm	
Non-linear Coefficient(n ² /Aeff)	-		1.4*10 ⁻⁹		W-1	
Effective Area(Aeff)@1550nm	20		-		um ²	
Maximum Input Power	-		23		dBm	
Operatomg Temperature Range	0°C		50°C		°C	
Storage Temperature Range	-40°C		85°C		°C	
Relative Humidity	< 85%				%	
Environmental/Reliability testing	Comply with Telcordia GR-2854 and GR-1221 standard					
Size	482.6(W)x350(D)x43.6(H) mm					

Dispersion Solution

Dispersion compensator

Specifications

Fiber Bragg grating (FBG)

Communication and internet service providers (CSP & ISP) are looking for ways to increase data rates in next-generation DWDM networks. In particular, data-center interconnect (DCI)/enterprise, fiber-to-the-premises (FTTx) and 5G X-Haul networks using intensity modulation direct detection (IMDD) require a simple, cost-effective, and reliable chromatic dispersion compensation solution when increasing the reach and data rate under which they operate. Fiberroad FBG-based DCM have been widely deployed as essential components of regional and metropolitan networks for more than 15 years. The FBG-DCM has dominated the FBG-based dispersion compensation market because the proven-reliable, compact modules are a totally passive solution that features ultra-low latency and low-insertion-loss.

Benefites of FBG-DCM

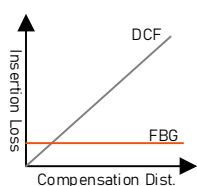

Ultra-Low Insertion Loss

The low loss enables a higher degree of freedom when optimizing your system with respect to reach and performance.

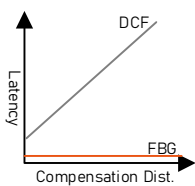

Ultra-Low latency

FBG-DCM latency less than 25 ns, a reduction of over 1000x compared to DCF.

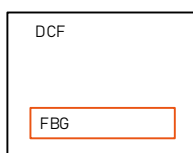

Ultra compact size

FBG design enables an immense space saving resulting in substantial OPEX AND CAPEX related savings.

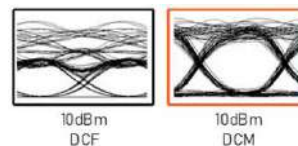

Zero non-linear Effects

Minimize the generation of non-linear effects, enabling the use of higher transmission power levels.

Module Dimension

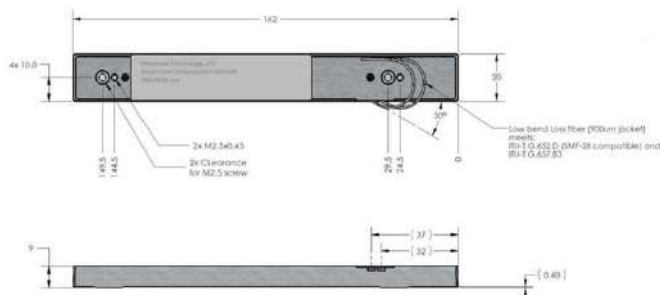

Specifications

Parameters	Option 1	Option 2	UNIT
Dispersion Compensation Level	20 to 100	20 to 200	KM
Channel Spacing	100	50 and 100	GHz
Operation Bandwidth	> 60	> 25	GHz
Insertion Loss	≤3.0	≤3.0	dB
Latency	< 25	< 25	ns
Operating Temperature	-5 to 70		°C
Storage Temperature	-40 to 85		°C

Dispersion Solution

Dispersion compensator

Specifications

Tunable Dispersion Compensator (TDCM)

The Fiberroad TDCM series is the only G.652 slope-matched tunable chromatic dispersion compensator on the market that provides adjustable, simultaneous compensation for all channel across the entire C-band, all within a single device .

System vendors who serve communication and internet service providers (CSP & ISP) are seeking ways to increase data rates in next-generation DWDM access networks. This is particularly true for data-center interconnect (DCI)/enterprise, fiber-to-the-premises (FTTx), and 5G X-Haul networks operating with intensity modulation direct detection (IMDD) modulation formats such as PAM-4.

Product Highlights

- ❖ Tunable: The TDCM provides highly accurate , dynamically adjustable chromatic dispersion compensation over a large range of dispersion values(from 0 to 80km with the same module).
- ❖ Full C-band coverage: Full C-band coverage,either on a 50GHz or 100GHz grid
- ❖ G.652 Slope-Matched: The TDCM compensates for the chromatic dispersion slope of the fiber, resulting in a precise , homogeneous residual dispersion for every channel of the C-band.
- ❖ Compact: The TDCM has dimensions of only 130x22x14mm.
- ❖ Low-Latency: The TDCM features a latency of less than 25ns, a reduction of over 1000x compared to dispersion compensating fiber(DCF), making it the perfect choice for time-sensitive networks.



Optionally integrate with EDFA/Optical Multiplexer

Specifications

Parameters	Specifications					Units
Channel Grid	50		100			GHz
Wavelength Range	1529.55 – 1567.54			1527.99 – 1566.31		nm
Compensation Range	0-80		-40 to 40	0-80		km
	0-40	40-80		0-40	40-80	
Typical -3dB bandwidth	34	30	34	68	50	GHz
Phase Ripple Std Deviation	≤0.1	≤0.13	≤0.12	≤0.12	≤0.15	rad
Slope-Matching Error	≤25	≤35	≤30	≤20	≤35	ps/nm
Dispersion Accuracy	≤2	≤2.5	≤2	≤2	≤3	km
Insertion Loss	< 6					dB
Tuning Stability	±5					ps/nm
Tuning Time	25					Sec
Polarization-dependent loss	≤0.5					dB
Polarization mode dispersion	≤1					ps
Maximum input power	< 27					dBm
Control interface	I ² C					
Voltage	5					V
Typical power consumption	4					W
Operating temperature	-5 to 70					°C
Storage temperature	-40 to 85					°C
Module Warm-Up Time	180					Sec
Life	20					Year

OSNR Solution

Optical power monitoring (OPM)

Specifications

The optical power monitoring (OPM) is a spectral analysis single disk for on-line spectral monitoring of the DWDM communication system, outputting the spectral curve data of the optical channel and the optical wavelength, power, and signal-to-noise ratio of each optical channel. In a simple function of the spectrometer. The network management system draws out the spectral curve and the optical channel performance list according to these data. Users can analyze the optical wavelength of the optical channel in the system drift, optical power changes and balance with the channel and the signal to noise ratio and channel usage and other information to achieve real-time monitoring of optical channel performance.

Product Highlights

- ❖ Real-time monitoring DWDM wavelength division system wavelength
- ❖ Real-time monitoring DWDM wavelength system per channel power
- ❖ Real-time monitoring DWDM wave division system signal to noise ratio
- ❖ Provide real-time monitoring of the spectral curve
- ❖ Real-time monitoring of optical channel performance, to provide performance monitoring list
- ❖ Support 1/2/4/8 direction real-time switching scan
- ❖ Strong network management functions: WEB, CLI, SNMP remote network management functions



Figure 1
Network Management Interface



Figure 2
OPM Modular Card

Specifications

Parameters	Index	Unit
Working Wavelength	1529-1561	nm
Channel Space	50/100	GHz
Single wave output power	-30 ~ -10	dBm
Wavelength detection accuracy	< 2.5	nm
Power detection accuracy	< 1.5	dBm
Check the number of optical ports	1/2/4/8	
Operating Temperature	-10 ~ +60	°C
Storage Temperature	-20 ~ +75	°C
Relative Humidity	5% ~ 95% No condensation	%
Power Consumption	< 5W	W

Optical Line Protection Solution

Specifications

Optical Line Protection Equipment (OLP) is a kind of equipment used in the field of optical fiber communication, which can automatically recognize the optical signal status of the main and backup. To avoid the main cable when the full resistance barrier, the protection of the normal communication. Optical path protection equipment mainly has real-time monitoring of optical power, optical path switching, alarm and other functions, the establishment of routing port on the rate, the interface is transparent, the switching routes are established in the light domain.

Product Highlights

- ❖ Reduce interrupt time of communication and improve maintenance efficiency with quickly recovering communication
- ❖ Remarkably reduce damage to network caused by fiber failure
- ❖ Increase network reliability and improve service quality
- ❖ Harmless switch between working path and secondary path and convenient for line overhaul and cutover
- ❖ Real-time monitoring power level of fiber
- ❖ Support remote control, easy management and maintenance
- ❖ Transparent transmission

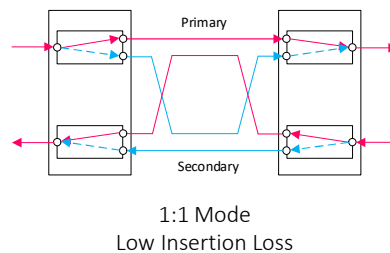
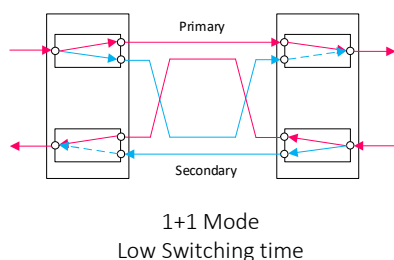

Figure 2
OLP Modular Card

Specifications

parameter	1:1 protection	1+1protection
Working wavelength(nm)	1310±50nm and 1550±50nm	
Monitor optical power range(dBm)	+ 23 ~ -50	
Monitor optical power accuracy(dB)	±0.25	
Monitor optical power resolution(dB)	±0.01	
Return loss(dB)	≥55	
Polarization dependent loss(dB)	≤0.05	
Wavelength dependent loss(dB)	≤0.1	
Insert loss(dB)	Transmit<1.2、Receive<1.2	Transmit<4、Receive<1.2
Switching time(ms)	<30	<15
Environment	Operating temperature (°C)	-10 ~ +60°C
	Storage temperature (°C)	-20 ~ +75°C
	Relative humidity	5%~95% Non-condensing
Power supply (V)	220V/AC, 50Hz; -48V/DC (optional)	
Power consumption(W)	< 5W	
Power down stating	on	
Size	26.5 (W) × 195 (H) × 252 (D) (mm)	

Optical Multiplexer

Specifications

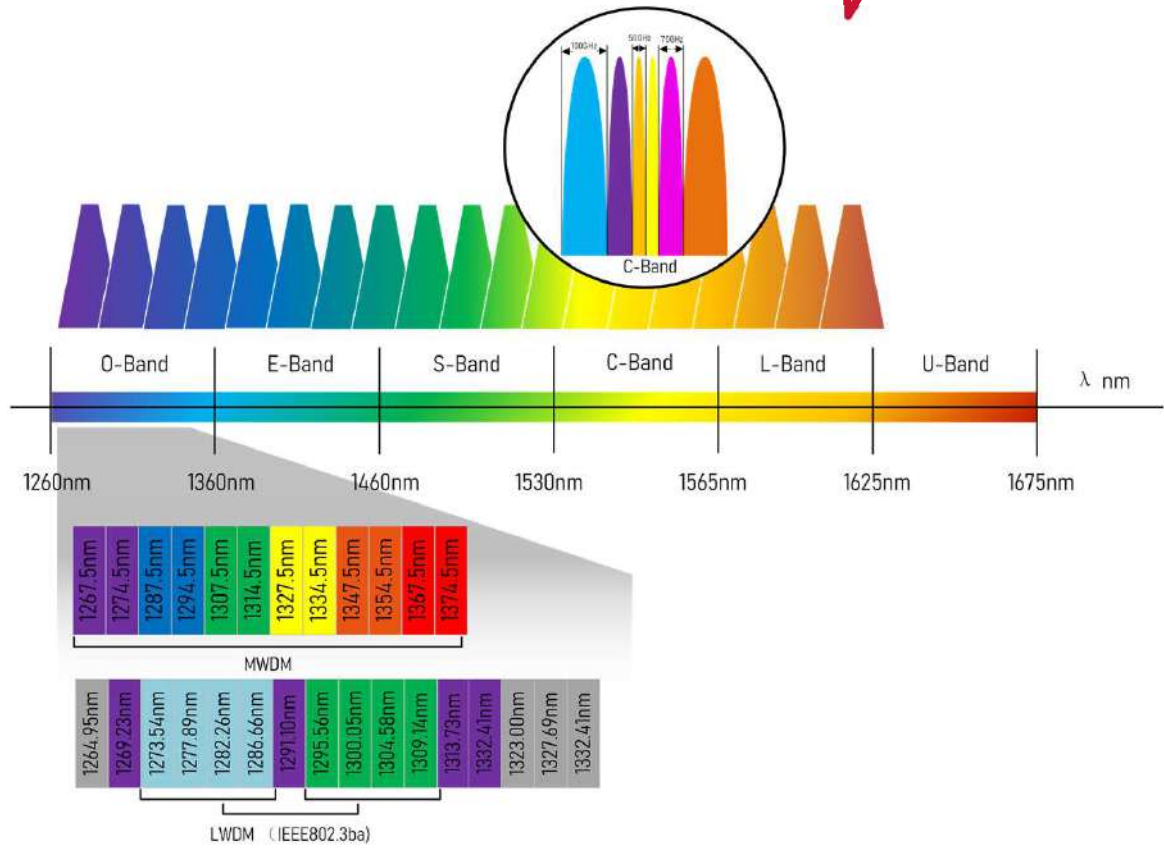

- 
Data Center
- 
Smart City
- 
4G & 5G
- 
Dark Fiber
- 
ISP/ICP



Optical Multiplexer

Specifications

Deploy on-demand

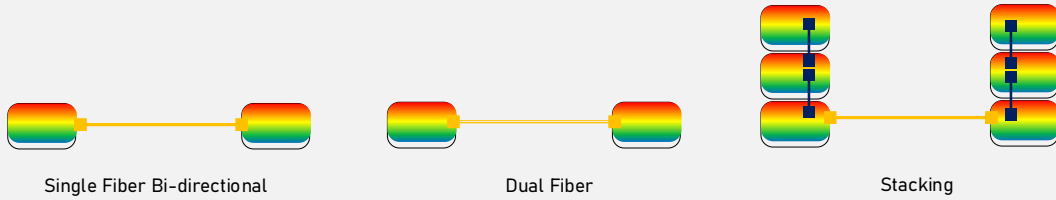

Multi application scenarios

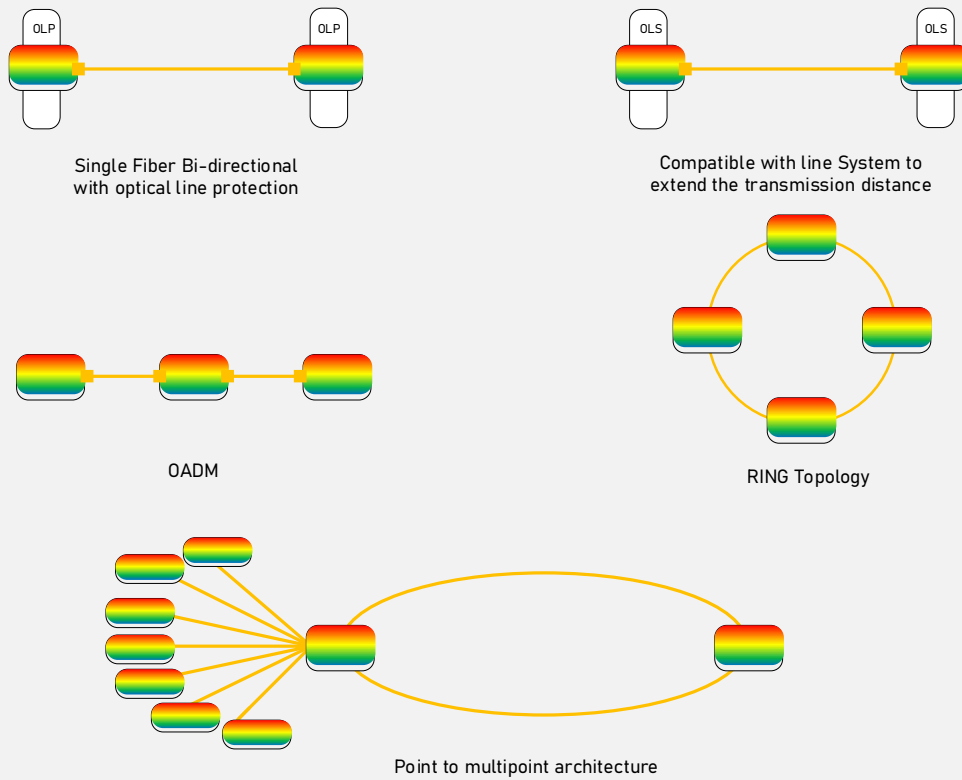

Multi channel spaces

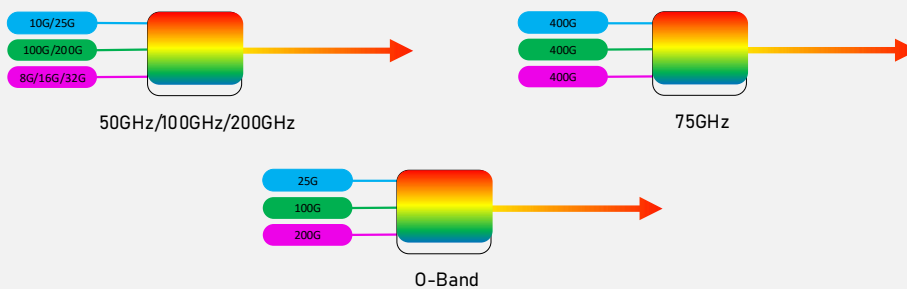

Optical Multiplexer

Specifications

Features

- ❖ Passive transparent any rate, any services multiplexing
- ❖ Compliant with all optical networking products (ITU grid)
- ❖ Passive optical multiplexer supported configuration: 4/8/16/48/96 channels
- ❖ Optionally integrate OSC, EDFA, OLP, etc.
- ❖ Support either single or dual fiber in PTP, Ring, OADM, PTMP network architecture
- ❖ Integrate with all Fiberroad products
- ❖ Supports 50GHz,75GHz,100GHz
- ❖ Low insertion loss
- ❖ Optionally industrial configuration

Main Benefits

- ❖ Customized per customer application requirements
- ❖ Standards-based and can integrate with third party solution
- ❖ Scalable solution, allowing customers to expand as needed, saving operating costs and resources

Recommended applications

- ❖ Expansion of existing fiber capacity regardless of service type
- ❖ Building scalable high capacity pay-as-you-grow optical networks
- ❖ Low cost fully passive optical layer solution

CWDM ITU Channels Overview

ITU-T G.694.2 defines 18 wavelengths for CWDM transport from 1270 to 1610, spaced at 20nm apart. The complete CWDM grid is shown as below

ITU Channel No.	Wavelength(nm)
27	1270
29	1290
31	1310
33	1330
35	1350
37	1370
39	1390
41	1410
43	1430
45	1450
47	1470
49	1490
51	1510
53	1530
55	1550
57	1570
59	1590
61	1610

Optical Multiplexer

Specifications

CWDM Tailor-make References

Code	Type	Description
#001	CWDM	8CH CWDM for Dual Fiber application, with OSC/Expand port and monitor port
#002	CWDM	8CH CWDM for Single Fiber Bi-directional, with OSC and monitor port
#003	CWDM	4CH CWDM for Ring or OADM application, with OSC and monitor port
#004	CWDM	16CH CWDM for Dual Fiber application, with OSC and Monitor port
#005	CWDM	Customized

DWDM ITU Channels Overview

ITU G.694.1 standard DWDM region is from 1528.77nm to 1563.86nm that resides mostly within the C band. DWDM can have 100GHz (0.8 nm) wavelength spacing for 40 channels, or 50GHz (0.4 nm) spacing for 80 channels. The complete channel grid for 50GHz & 100GHz DWDM is shown as below.

Channel No.	Wavelength(nm)	Frequency(THz)	Channel Port No.	Wavelength(nm)	Frequency(THz)
D13	1567.13	191.30	D37	1547.72	193.70
H13	1566.72	191.35	H37	1547.32	193.75
D14	1566.31	191.40	D38	1546.92	193.80
H14	1565.91	191.45	H38	1546.52	193.85
D15	1565.50	191.50	D39	1546.12	193.90
H15	1565.09	191.55	H39	1545.72	193.95
D16	1564.68	191.60	D40	1545.32	194.00
H16	1564.27	191.65	H40	1544.92	194.05
D17	1563.86	191.70	D41	1544.53	194.10
H17	1563.45	191.75	H41	1544.13	194.15
D18	1563.05	191.80	D42	1543.73	194.20
H18	1562.64	191.85	H42	1543.33	194.25
D19	1562.23	191.90	D43	1542.94	194.30
H19	1561.83	191.95	H43	1542.54	194.35
D20	1561.42	192.00	D44	1542.14	194.40
H20	1561.01	192.05	H44	1541.75	194.45
D21	1560.61	192.10	D45	1541.35	194.50
H21	1560.20	192.15	H45	1540.95	194.55
D22	1559.79	192.20	D46	1540.56	194.60
H22	1559.39	192.25	H46	1540.16	194.65
D23	1558.98	192.30	D47	1539.77	194.70
H23	1558.58	192.35	H47	1539.37	194.75
D24	1558.17	192.40	D48	1538.98	194.80
H24	1557.77	192.45	H48	1538.58	194.85

Optical Multiplexer

Specifications

D25	1557.36	192.50	D49	1538.19	194.90
H25	1556.96	192.55	H49	1537.79	194.95
D26	1556.55	192.60	D50	1537.40	195.00
H26	1556.15	192.65	H50	1537.00	195.05
D27	1555.75	192.70	D51	1536.61	195.10
H27	1555.34	192.75	H51	1536.22	195.15
D28	1554.94	192.80	D52	1535.82	195.20
H28	1554.54	192.85	H52	1535.43	195.25
D29	1554.13	192.90	D53	1535.04	195.30
H29	1553.73	192.95	H53	1534.64	195.35
D30	1553.33	193.00	D54	1534.25	195.40
H30	1552.93	193.05	H54	1533.86	195.45
D31	1552.52	193.10	D55	1533.47	195.50
H31	1552.12	193.15	H55	1533.07	195.55
D32	1551.72	193.20	D56	1532.68	195.60
H32	1551.32	193.25	H56	1532.29	195.65
D33	1550.92	193.30	D57	1531.90	195.70
H33	1550.52	193.35	H57	1531.51	195.75
D34	1550.12	193.40	D58	1531.12	195.80
H34	1549.72	193.45	H58	1530.72	195.85
D35	1549.32	193.50	D59	1530.33	195.90
H35	1548.91	193.55	H59	1529.94	195.95
D36	1548.51	193.60	D60	1529.55	196.00
H36	1548.11	193.65	H60	1529.16	196.05

DWDM Tailor-make References

Code	Type	Description
#001	DWDM	8CH 100GHz DWDM for Dual Fiber PTP application, integrate OSC
#002	DWDM	8CH 100GHz DWDM for Dual Fiber PTP application, integrate OSC and Expand port
#003	DWDM	8CH 100GHz DWDM for Single Fiber Bi-directional PTP application, integrate OSC and EDFA port
#004	DWDM	8CH 100GHz DWDM for Single Fiber Bi-directional PTP application, integrate OSC, Expand and EDFA
#005	DWDM	8CH 100GHz DWDM for Single Fiber Bi-directional with OLP PTP application, integrate OSC ,Expand and EDFA port
#006	DWDM	4CH 100GHz DWDM Dual Fiber for Ring or OADM application, integrate OSC and Expand port
#007	DWDM	8CH 100GHz DWDM Dual Fiber for Ring or OADM application, integrate OSC and Expand port

Optical Multiplexer

Specifications

DWDM Tailor-make References

#008	DWDM	4CH 100GHz DWDM Single Fiber Bi-directional for Ring or OADM application, integrate OSC, Expand and EDFA port
#009	DWDM	8CH 100GHz DWDM Single Fiber Bi-directional for Ring or OADM application, integrate OSC, and EDFA port
#010	DWDM	16CH 100GHz DWDM for Dual Fiber PTP application, integrate OSC
#011	DWDM	16CH 100GHz DWDM for Single Fiber Bi-directional PTP application, integrate OSC and EDFA port
#012	DWDM	40CH 100GHz DWDM for Dual Fiber PTP application, integrate OSC
#013	DWDM	40CH 50GHz DWDM for Single Fiber Bi-directional PTP application, integrate OSC
#014	DWDM	96CH 50GHz DWDM for Dual Fiber PTP application, integrate OSC and EDFA port
#015	DWDM	64CH 75GHz DWDM for Dual Fiber PTP application, integrate OSC port
#016	DWDM	Customized

Accessories



Cable Management



Smart Cleaner



Ear Mount



RFID



Uniboot Fiber Patch Cable

Fiberroad founded in 2008, is committed to developing and manufacturing and selling network communication products. In particular, the focus on fiber optical technologies, Ethernet technologies and the integration of broadband access technologies. With leading-edge technology and high quality service as the driving force, we continued steady growth, and become a top global equipment supplier of innovative last-mile access in the telecommunications market.

As our professional engineering team have devoted ourselves to the R&D for a long time, so that the products have been quiet mature. We have received much popular recognition from our current Telecom operators, Telecom engineering contractors, and Solution Partners in the world. This alliance covers Europe, Asia, the Middle East, Africa, plus North and South America. This global partnership receives direct engineering and technical support from our company headquarters in Shenzhen.

As services such as voice and multimedia are moving to IP based technologies, carriers have found that their core networks can be operated more effectively and economically if the public switching networks are migrated to a next generation IP based networks. This proactive thinking will allow us to continue developing IP Camera solutions for today and tomorrow's markets.