



SMART INDUSTRIAL ETHERNET SWITCH DIN RAIL MOUNT

Installation Guide



Copyright©2022 Fiberroad Technology Co., Ltd. All rights reserved. No part of this publication may be reproduced, stored in a retrieval system or transmitted in any form, be it electronically, mechanically, or by any other means such as photocopying, recording or otherwise, without the prior written permission of Fiberroad Technology Co., Ltd. (Fiberroad)

Information provided by Fiberroad is believed to be accurate and reliable. However, no responsibility is assumed by Fiberroad for its use nor for any infringements of patents or other rights of third parties that may result from its use. No license is granted by implication or otherwise under any patent rights of Fiberroad.

The information contained in this publication is subject to change without notice.

Trademarks

Fiberroad's trademarks have been identified as such. However, the presence or absence of such identification does not affect the legal status of any brand.

Units of Measurement

Units of measurement in this publication conform to SI standards and practices.

Jan 01, 2022

Preface

Thank you for purchasing the Fiberroad Industrial Ethernet Switch series products.

Be sure to carefully read this manual before using the product. This manual will be helpful later on, so after reading it, be sure to store it in a safe place. This manual explains the necessary functions and operating methods for adequately using the Industrial Ethernet Switch.

Purpose

This guide documents the hardware feature of the Fiberroad Industrial Ethernet Switches. It describes the physical and performance characteristics of each switch, explains how to install a switch.

This guide does not describe system messages that you might receive or how to configure your switch.

Conventions

This document uses the following conventions and symbols for notes, cautions, and warnings.

Note: This Means reader takes note. Notes contain helpful suggestions or references to materials not included in this manual.

Caution: **This** Means the reader is careful. In this situation, you might do something that could result in equipment damage or data loss.

Warning: This warning symbol means danger. You are in a situation that could cause bodily injury. Before you work on any equipment, be aware of the hazards involved with electrical circuitry and be familiar with standard practices for preventing accidents. Use the statement number provided at the end of each warning to locate its translation in translated safety warnings that accompanied this device.



Warning!

- **Please don't open the cover**

Opening the cover of this equipment is forbidden.

This has an electric shock hazard. Besides, this is a factor that may cause faults.

- **Please don't use it when the equipment is abnormal**

In case of abnormal conditions like fume, peculiar smell, strange sounds, etc., please stop using the equipment lest fire or electric shock occurs. Please switch it off immediately, and then ask the sale shop or sale site from which you purchased it for repair after the smoke indeed disappears. Never repair it by yourself, lest that hazard occur.

- ❖ When using AC power: please pull out the power plug from the socket.
- ❖ When using DC power: please remove the power cable from the junction board.

- **Please don't damage the power wires**

Please don't scratch, damage or stretch the power wires. Otherwise, the power wires may break and cause fire or electric shock hazards.

- **Plugin the plug properly**

When using AC power, the power plug should be fully inserted. Besides, please don't use loose sockets to avoid harmful contact. Otherwise, fire or electric shock may occur.

- **The power wires should be firmly connected with the junction board**

When using DC power, the power wires should be firmly connected with the junction board. As long as the [0V], [-48V] and [FG] junctions are contacted, not only the internal power of the equipment will fail, but also fire or electric shock may occur.

- **Hold the plug when plugging it in/out**

When plugging in or pulling out the power wires, please make sure to hold the plug with your hand. Stretching the wires parts may damage them and cause electric shock or fire.

- **Please don't touch the plug/junction board with a wet hand**

Please don't touch the power plug or connect the junctions with a damp hand. Otherwise, an electric shock may occur.

- **Plug/junction board cleaning**

Please make sure that the plug and junction board are not covered with dust before connecting them. If they are covered with dust, fire or electric shock may occur.

- **Please don't touch the equipment in thunder**

When thundering, please don't perform connection tasks of communication cables and touch the equipment. Touching the equipment in thunder may cause electric shock.

- **Don't interfere with ventilation**

The vents are designed lest that the internal temperature increases. Please don't place the equipment at unventilated positions or place objects on or near the vents. Otherwise, its internal temperature may increase and cause fire or faults.

Please don't place objects on the soft power wires

Please don't place objects on the power wires. The breakage of it may cause fire or electric shock.

- **Pull out the soft power wires from the socket in case of damage**

When the soft power wires are damaged, please switch the power off immediately and ask the sale shop or sale site from which you purchased it for repair. Letting it alone may cause fire or electric shock.

- **Pull it out from the socket in case of damage**

If the host is dropped or damaged, please switch the power off immediately and ask the sale shop or sale site from which you purchased it for repair—letting it alone may cause fire or electric shock.

- **Please don't place it on unstable sites**

Please don't place the equipment at rocky, declining or unstable sites. Otherwise, it may be damaged by dropping or overturning.

- **Please don't place it at sites with the abominable environment**

Placing the equipment in the following areas will shorten its life and cause faults. Please conserve it properly. Don't place it in the following areas.

- Very damp or dusty sites

- Sites that generate lampblack or corrosive gases

- Continuously vibrated sites

- Sites under direct sunlight

- High-temperature sites near ovens or other hot apparatus

- **Please don't impose pressure at will**

Please don't impose pressure on the connector or touch it with metal at will. Otherwise, a fault may occur

CONTENTS

Chapter 1 Product Overview	8
1.1 Product Overview.....	8
1.1 Models Supported.....	8
1.2 Front Panel Overview.....	9
1.3 Ports and Slots	10
1.3.1 10/100/1000 BASE-T Downlink Ports.....	10
1.3.2 100/1000Mb/s SFP Module Uplink Slots.....	10
1.3.4 DC Power Connector.....	11
1.3.5 Alarm Connector(Bases on models).....	11
1.4 LEDs.....	12
1.4.1 System LED.....	12
1.4.2 Power LED	13
1.4.3 Port Status LEDs	13
1.5 Management Options.....	13
1.6 Rear Panel.....	14
Chapter 2 Switch Installation.....	15
2 Installation Guidelines.....	15
2.2 General Guidelines	16
2.3 Connecting to Power	17
2.3.1 Tools and Equipment.....	17
2.3.2 Installing the Power Supply on a DIN Rail, Wall, or Rack Adapter.....	17
2.3.3 Grounding the Switch.....	18
2.3.4 Connecting the Power Supply to a DC Power Source.....	19
2.3.5 Wiring the DC Power Source	20
2.3.6 Attaching the Power Connectors to the Switch.....	22
2.3.7 Applying Power to the Power Converter.....	22
2.4 Installing the Switch on a DIN Rail.....	23
2.4.1 Installing the Switch on Wall	24
2.5 Connecting Alarm Circuits.....	25
2.6 Connecting Destination Ports	26
2.6.1 Connecting to 10/100/1000 Lan Ports.....	26
2.6.2 Installing and Removing SFP Modules.....	27
2.6.3 Installing SFP Modules into SFP Module Slots	27
2.6.4 Removing SFP Modules from SFP Module Slots	29
2.6.5 Connecting to SFP Modules	29
2.7 Running Express Setup.....	30
2.7.1 Required Equipment.....	30
2.7.2 Express Setup Procedure	31
Chapter 3 Troubleshooting and Maintenance.....	34
3 Troubleshooting.....	34
3.1 Diagnosing Problem	34
3.1.1 Switch LEDs.....	34
3.2 Switch Connections	35

3.2.1 Bad or Damaged Cable.....	35
3.2.2 Ethernet and Fiber-Optic Cables	35
3.3. Link Status.....	35
3.4 10/100/1000 Lan Port Connections	36
3.5 SFP Module.....	36
3.6 Interface Settings.....	36
3.7 Ping End Device	36
3.8 Spanning Tree Loops.....	36
3.9 Switch Performance.....	37
3.9.1 Autonegotiation and Network Interface Cards.....	37
3.9.2 Cabling Distance	37
3.10 Resetting the Switch	38
3.11 The Switch Serial Number	38
3.12 Cable and Connectors.....	38
3.12.1 Connector Specifications.....	38
3.12.2 10/100/1000 Lan Ports	38
3.12.3 Fiber- Optic Module Connectors.....	39
3.12.4 Console Port	39
3.13 Fiber-Optic Module Cables	40



Revision History

Version	Date	Author	Reasons of Change	Section(s) Affected
1.0	2017/12/04		Initial Release	All

Chapter 1 Product Overview

This chapter describes the hardware characteristics in detail, including but not limited to the following:

- ❖ Product Overview
- ❖ Front Panel Overview
- ❖ Ports and Slots

1. Product Overview

The Fiberroad Industrial Ethernet Switch series are compact, rugged switches aimed at operational technology (OT) users with limited IT network knowledge. The Switches provide an easy transformation from the legacy factory to a digital solution. Machine builders and machine-to-machine (M2M) solutions are attractive entry level products as a GUI-based, lightly-managed switch. The switch is a good fit for locations with harsh temperatures and small spaces and is Power over Ethernet (PoE) capable of zero IT management.

The Switch is ideal for industrial Ethernet applications where small and easy-to-be-managed hardened products are required, including factory automation, intelligent transportation systems, city-surveillance programs, building automation etc.

The Industrial Ethernet Series Switches complement the current industrial Ethernet portfolio of related Fiberroad industrial switches, such as the FR-7M, FR-7N, FR-6N, FR-6R Series Switches.

The Industrial Ethernet Switch can be easily installed on your network. I.e., FR-7M, FR-6R through a user-friendly web device manager, the switches provides easy out-of-the-box configuration and simplified operational manageability to deliver advanced and secure multi-services over industrial networks.

1.1 Models Supported



FR-7M Managed Industrial Ethernet Switch Series
FR-7N Industrial Ethernet Switch Series





FR-6N Industrial Ethernet Switch Lite Series
FR-6R Smart Industrial Ethernet Switch Lite Series

1.2 Front Panel Overview

The illustrations in this section provide an overview of the variety of components available on the various switch models in this product family. Not all models are illustrated.

Figure 1 FR-7M3816 front panel shown



	SYS and PWR LEDs
	10/100/1000 Base-T ports and LEDs
	SFP module slots and LEDs

1.3 Ports and Slots

Note: Different configurations are available. Not all ports and slots are present in all configurations

1.3.1 10/100/1000 BASE-T Downlink Ports

You can set the 10/100/1000BASE-T downlink ports to operate at 10 or 100 or 1000Mb/s in full-duplex or half-duplex mode. You can also put these ports for speed and duplex auto-negotiation in compliance with IEEE 802.3AB. (The default setting is auto-negotiate.) When set for auto-negotiation, the port senses the speed and duplex settings of the attached device and advertises its capabilities. If the connected device also supports auto-negotiation, the switch port negotiates the best connection (that is, the fastest line speed that both devices support and full-duplex transmission if the attached device supports it) and configures itself accordingly. In all cases, the connected device must be within 328 feet (100 meters). 1000BASE-T traffic requires Category 5e or above, 100BASE-TX traffic requires Category 5 cable. 10BASE-T traffic can use Category 3 or Category 4 cables.

When connecting the switch to workstations, servers, routers, and IP phones, ensure the cable is straight-through.

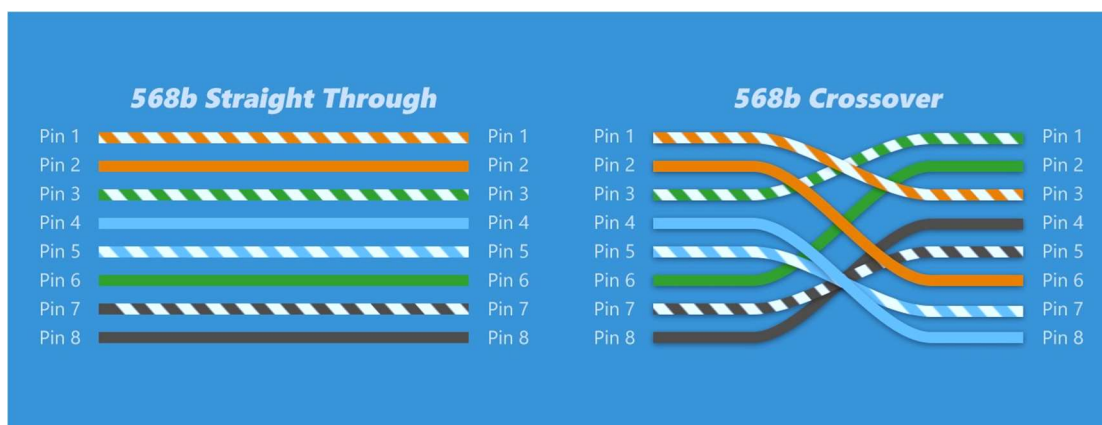

Figure 2 Straight Through and Crossover cable structure

1.3.2 100/1000Mb/s SFP Module Uplink Slots

The IEEE 802.3u 100 Mb/s SFP module uplink slots provide full-duplex 100 or 1000 Mb/s connectivity over multi-mode (MM) fibre cables or single-mode (SM) fibre cables. These ports use an SFP fibre-optic transceiver module that accepts a dual or single LC connector. Check the SFP specifications for the cable type and length.

Interface Type	Wavelength (nm)	Typical Reach (km)
1000BASE-SX	850nm	550m
1000BASE-LX	1310nm	550m/5km
1000BASE-LX10	1310nm	10km
1000BASE-EX	1310nm	40km
1000BASE-ZX	1550nm	80-100km

1000BASE-BX10	1490nm/1550nm	10km
---------------	---------------	------

Figure 3 The SFP specifications for the cable type and length

1.3.3 Connectors

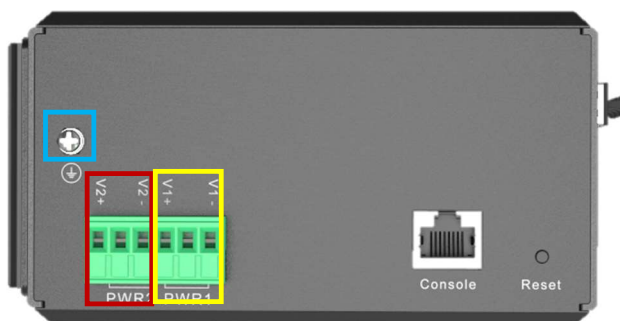





Figure 4 FR-7M3816 top panel shown

	Protective ground connection
	Power Connector DC1 and integrates alarm connector
	Power Connector DC2 and integrates alarm connector

1.3.4 DC Power Connector

Connects the DC power to the switch through the top panel connectors. The switch has a dual-feed DC power supply; two connectors provides primary and secondary DC power (PWR1 and PWR2).

The switch power connectors are attached to the switch chassis. Each power connector has screw terminals for terminating the DC power. All connectors are connected to the switch top panel with the captive screws.

The power connector labelling is on the panel. The positive DC power connection is labelled "+", and the return connection is labelled "-".

The switch can operate with a single power source or with dual power sources. When both power sources are operational, the switch draws power from the DC source with the higher voltage. If one of the two power sources fails, the other control the switch.

1.3.5 Alarm Connector(Bases on models)

Connects the alarm signals to the switch through the alarm connector. The switch supports one alarm output relay. The alarm connection is integrated into the DC power terminal.

The alarm output circuit is a relay with a normally open and closed contact. The

switch is configured to detect faults used to energise the relay coil and change the state on both of the relay contacts: ordinarily open contacts close, and normally closed contacts open. The alarm output relay can control an external alarm device, such as a bell or a light.

1.4 LEDs

Uses the LEDs to monitor the switch status, activity and performance.



Figure 5 FR-7M3816 LEDs shown

SYS	System LED
PWR	DC Power connector LED
RJ45(LED)	LAN port LED
LINK	SFP LED

1.4.1 System LED

The system LED shows whether the system is receiving power and is functioning correctly.

Colour	System Status
Off	The system is not powered on.
Green	The system is operating normally.
Red	The switch failed ACT 2 verification. The configuration running on the switch is not compatible with the running software. The switch is not functioning correctly.

1.4.2 Power LED

Colour	System Status
Off	The system is not powered on, or Power is not present on the circuit.
Green	The power is present on the associated circuit; the system operates normally.
Red	The power is not present on the associated circuit, and the power supply alarm is configured.

Notes: The power LEDs show that power is not present on the switch if the power input drops below the low valid. The power status LEDs only show that administration is current if the voltage at the switch input exceeds the reasonable level.

1.4.3 Port Status LEDs

Colour	System Status
Off	No Link
Solid Green (LAN Port)	Link present
Blinking amber (LAN Port)	Activity. Port is sending or receiving data
Solid Green (SFP)	Link present
Blinking Green (SFP)	Activity. Port is sending or receiving data

1.5 Management Options

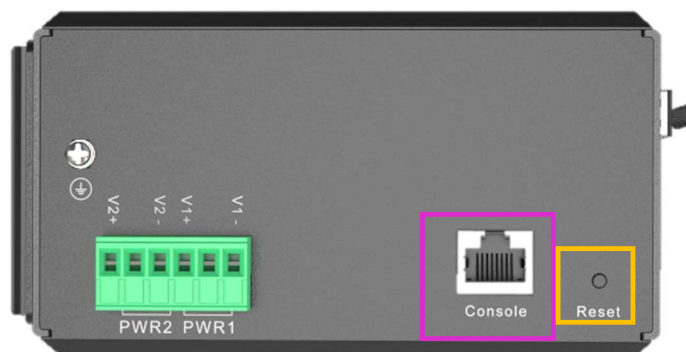



Figure 6 FR-7M3816 top panel shown

	The port for Command-Line configuration
	The port for restoring factory default settings

Notes: 1, The alarm output relay can be used to control an external alarm device, such as a bell or a light.

2, Utilizes the Lan port for the WebGUI management.

1.6 Rear Panel

The rear panel of the switch has a buckle for installation on a DIN rail and two kits for wall mount installation.

The buckle is spring-loaded to move down to position the switch over a DIN rail and return to the original position to secure the switch to a DIN rail.



Figure 6 Rear Panel

Chapter 2 Switch Installation

This chapter describes how to install your switch, verify the boot fast, and connect the switch to other devices. It also includes information specifically for installation in hazardous environments.

- ❖ Preparing for installation
 - ❖ Connection to Power
 - ❖ Installing the Switch
 - ❖ Connecting Alarm Circuits
 - ❖ Connecting Destination Ports
 - ❖ Where to Go Next
-

Preparing for Installation

This section provides information about these topics

2 Installation Guidelines

When determining where to place the switch, observe these guidelines

Environment and Enclosure Guidelines

- ❖ This equipment is intended for use in a Pollution Degree 2 industrial environment, in overvoltage Category II applications (as defined in IEC publication 60664-1), at altitudes up to 9842 ft (3 km) without derating.
- ❖ This equipment is considered Group 1, Class A industrial equipment, according to IEC/CISPR Publication 11. Without appropriate precautions, there may be potential difficulties ensuring electromagnetic compatibility in other environments due to conducted as well as a radiated disturbance.
- ❖ This equipment is supplied as open-type equipment. It must be mounted within an enclosure that is suitably designed for those specific environmental conditions that will be present and appropriately designed to prevent personal injury resulting from accessibility to live parts. The enclosure must have suitable flame-retardant properties to prevent or minimise flame spread, complying with a flame-spread rating of 5VA, V2, V1, V0 (or equivalent) if nonmetallic. The interior of the enclosure must be accessible only by using a tool. Subsequent sections of this publication might contain additional information regarding specific enclosure type ratings required to comply with certain product safety certifications.

2.2 General Guidelines

Before installation, observe these general guidelines:

Caution: Proper ESD protection is required whenever you handle Fiberroad equipment. Installation and maintenance personnel should be adequately grounded by using ground straps to eliminate the risk of ESD damage to the switch.

Do not touch connectors or pins on component boards. Do not touch circuit components inside the switch. When not in use, store the equipment in appropriate static-safe packaging.

- ❖ If you are responsible for applying a safety-related programmable electronic system(PES), you need to be aware of the safety equipment in appropriate static-safe packaging.

Caution: The device is designed to mount on a DIN rail that conforms to Standard EN50022. or mount on a wall that serves standard EN60715

When determining where to place the switch, observe these guidelines:

- ❖ Before installing the switch, verify that it is operational by powering it on and observing LEDs.
- ❖ For 10/100/1000 ports, the cable length from a switch to an attached device cannot exceed 328 feet (100 meters).
- ❖ For 100/1000BASE-FX fibre-optic ports, the cable length from a switch to a connected device cannot exceed the SFP specific length.
- ❖ Clearance to front and rear panels meets these conditions:
 - Front-panel LEDs can be easily read.
 - Access to ports is sufficient for available cabling.
 - Front-panel direct current (DC) power connectors and the alarm connector are within reach of the connection to the DC power source.
- ❖ Airflow around the switch must be unrestricted. To prevent the switch from overheating, you must have the following minimum clearances:
 - Top and bottom: 2.0 in. (50.8 mm)
 - Sides: 1.0 in. (25.4 mm)
 - Front: 2.0 in. (50.8 mm)

Caution: 1, When the switch is installed in an industrial enclosure, the temperature within the enclosure is more significant than the average room temperature outside the enclosure.

2, Ensure temperatures inside the enclosure conform to device specifications

- ❖ Cabling is away from sources of electrical noise, such as radios, power lines, and fluorescent lighting fixtures.

2.3 Connecting to Power

2.3.1 Tools and Equipment

- ❖ Obtain these necessary tools and equipment:
- ❖ Ratcheting torque flathead screwdriver.
- ❖ For the protective ground connector, obtain a single or pair of stud size six ring terminals.
- ❖ Crimping tool
- ❖ 10-gauge copper ground wire
- ❖ For DC power connections, use twisted-pair copper appliance wiring material(AWM) wire.
- ❖ Wire-stripping tools for stripping 10- and 18- gauge wires.
- ❖ A screwdriver.
- ❖ A flat-blade screwdriver.

2.3.2 Installing the Power Supply on a DIN Rail, Wall, or Rack Adapter

Installing the power converter on a DIN rail, wall, or rack as you would a switch module

Warning: This equipment is supplied as “open structure” equipment. It must be mounted within an enclosure that is suitably designed for those specific environmental conditions that will be present and appropriately designed to prevent personal injury resulting from accessibility to live parts. The interior of the enclosure must be accessible only by using a tool.

The enclosure must meet at least IP54 or NEMA type 4 minimum enclosure rating standards.

Caution: To prevent the switch assemble from overheating, there must be sufficient spacings, as explained under installation guidelines, between any other switch assembly.

2.3.3 Grounding the Switch

Make sure to follow any grounding requirements at your site.

Warning: This equipment must be grounded. Never defeat the ground conductor or operate the equipment without a suitably installed ground conductor. Contact the appropriate electrical inspection authority or an electrician if you are uncertain that suitable grounding is available.

Warning: This equipment is intended to be grounded to comply with emission and immunity requirements. Ensure that the switch functional ground lug is connected to earth ground during everyday use.

Caution: To make sure that the equipment is reliably connected to earth ground, follow the grounding procedure instructions, and use a UL-listed ring terminal lug suitable for number 10-to-12 AWG wire, such as Hollingsworth part number R3456B or equivalent)

Caution: Use at least a four mm² (0.006 in²) conductor to connect to the external grounding screw.

The ground lug is not supplied with the switch. You can use one of these options:

- ❖ Single ring terminal
- ❖ Two single ring terminals

To ground the switch to earth ground by using the ground screw, follow these steps:

1. Use a standard Phillips screwdriver or a ratcheting torque screwdriver with Phillip's head to remove the ground screw from the switch's front panel. Store the ground screw for later use.
2. Use the manufacturer's guidelines to determine the wire length to be stripped.
3. Insert the ground wire into the ring terminal lug, and using a crimping tool, crimp the terminal to the wire. If two ring terminals are used, repeat this action for a second ring terminal.



Figure 7 Crimping the Ring Terminal

4. Slide the ground screw through the terminal.
5. Insert the ground screw into the available ground screw opening on the front panel.
6. Use a ratcheting torque screwdriver to tighten the ground screws and ring terminal to the switch top panel. The torque should not exceed 4.5 in-lb (0.51 N-m).



Figure 8 Ground-Lug Screw

7. Attach the other end of the ground wire to a grounded bare metal surface, such as a ground bus, a grounded DIN rail, or a grounded basic rack.

2.3.4 Connecting the Power Supply to a DC Power Source

Note: Use copper conductors only, rated at a minimum temperature of 167°F (75°C).

Warning: Use twisted-pair supply wires suitable for 86°F (30°C) above surrounding ambient temperature outside the enclosure.

1. Measure a single length of stranded copper wire long enough to connect the power converter to the earth ground.

The wire colour might differ depending on the country that you are using it in.

For connections from the power converter to earth ground, use shielded 14-AWG stranded copper wire.

2. Measure the length of twisted-pair copper wire long enough to connect the power converter to the DC power source.

For DC connections from the power converter to the DC source, use 10-AWG twisted-pair copper wire.

3. Using a 14-gauge wire-stripping tool, strip the ground wire and both ends of the twisted pair wires to 0.25 inches (6.3mm) ± 0.02 inches (0.5 mm). Do not strip more than 0.27 inches (6.8 mm) of insulation from the wires. Stripping more than the recommended amount of wire can leave exposed wire from the power and relay connector after installation.

4. Connect one end of the stranded copper wire to a grounded bare metal surface, such as a ground bus, a grounded DIN rail, or a grounded basic rack.

5. Insert the other end of the exposed ground wire lead into the earth-ground wire connection on the power converter terminal block. Note that the position of the power converter may vary on different switch models.

6. Tighten the earth-ground wire connection terminal block screw.

Note: Torque to 8 in.-lb, not to exceed ten in-lb.

Warning: An exposed wire lead from a DC-input power source can conduct harmful levels of electricity. Be sure that no exposed portion of the DC-input power source wire extends from the power and relay connector.

7. Insert the twisted-pair wire leads into the terminal block line and neutral connections.

Lead into the line wire connection. Ensure that only wire with insulation extends from the connectors.

8. Tighten the line and neutral terminal block screws.

Note: Torque to 8 in.-lb, not to exceed ten in-lb.

9. Connect the red wire to the positive pole of the DC power source, and connect the black wire to the return pole. Ensure that each bar has a current-limiting-type fuse rated to 30 Amp.

2.3.5 Wiring the DC Power Source

Read these cautions and warnings before wiring the switch to the DC power source.

Warning: A readily accessible two-poled disconnect device must be incorporated in the fixed wiring.

Warning: This product relies on the building's installation for short-circuit (overcurrent) protection. Ensure that the protective device is rated not more significant than 6A.

Warning: Installation of the equipment must comply with local and national electrical codes.

Warning: Before performing any following procedures, ensure that power is removed from the DC circuit.

Warning: Only trained and qualified personnel should be allowed to install, replace, or service this equipment.

To wire the switch to a DC power source, follow these steps:

1. Locate the two power connectors on the switch front panel labelled PWR1 and

PWR2.

2. Identify the connector positive and return DC power connections. The power connectors DC-A and DC-B labels are on the switch panel, as displayed below.

3. Measure two strands of twisted-pair copper wire (16-to-18 AWG) long enough to connect to the DC power source.

Label	Connection
V+ Positive	DC power connection
V- Return	DC power connection

4. Using an 18-gauge wire-stripping tool, strip each of the two twisted-pair wires coming from each DC-input power source to 0.25 inches (6.3 mm) ± 0.02 inches (0.5 mm). Do not strip more than 0.27 inches (6.8 mm) of insulation from the wire. Stripping more than the recommended amount of wire can leave exposed wire from the power connector after installation.



Figure 9 Stripping the Power Connection Wire

1	0.25 in. (6.3mm) ± 0.02 in. (0.5mm)
---	-------------------------------------

5. Remove the two captive screws that attach the power connector to the switch and remove the power connector.

Remove both connectors if you are connecting to two power sources.



Figure 10 DC power connector receptacle

6. On the power connector, insert the exposed part of the positive wire into the connection labelled “+” and the exposed portion of the return wire into the link marked “-”. Make sure that you cannot see any wire lead. Only wire with insulation should extend from the connector.

Warning: An exposed wire lead from a DC-input power source can conduct harmful levels of electricity. Be sure that no exposed portion of the DC-input power source wire extends from the connector(s) or terminal block(s).

7. Use a ratcheting torque flathead screwdriver to torque the power connector captive screws (above the installed wire leads) to 2in-lb (0.226 Nm).

Caution: Do not over-torque the power connector's captive screws. The torque should not exceed 2in-lb (0.226Nm).

8. Connect the other end of the positive wire to the positive terminal on the DC power source, and connect the other end of the return wire to the return terminal on the DC power source.

When you are testing the switch, one power connection is sufficient. If you are installing the controller and are using a second power source, repeat Step 4 through Step 8 using the second power connector.

2.3.6 Attaching the Power Connectors to the Switch

To attach the power connectors to the switch's front panel, follow these steps: 1 Insert one power connector into the DC(PWR 1 and 2) receptacle on the switch front panel.

When you are testing the switch, one power source is sufficient. If you are installing the switch and are using a second power source, repeat this procedure for the second power connector (PWR2), which installs just below the primary power connector (PWR1).

When installing the switch, secure the wires coming from the power connector so that they cannot be disturbed by casual contact. For example, use tie wraps to connect the wires to the rack.

2.3.7 Applying Power to the Power Converter

Move the circuit breaker for the AC outlet or the DC control circuit to the on position.

The LED on the power converter front panel is green when operating normally. The LED is off when the unit is not powered or is not operating normally. After the power is connected, the switch automatically begins the power-on

A self-test (POST) is a series of tests verifying that the switch functions properly.

Installing the Switch

This section describes how to install the switch

- ❖ Installing the Switch on DIN Rail
- ❖ Installing the Switch from on Wall

Warning: This equipment is supplied as "open type" equipment. It must be mounted within an enclosure that is suitably designed for those specific environmental conditions that will be present and appropriately designed to prevent personal injury resulting from accessibility to live parts. The interior of the enclosure must be accessible only by the use of a tool.

The enclosure must meet IP 54 or NEMA type 4 minimum enclosure rating standards. Statement 1063

Warning: When used in Class I, Division 2, hazardous location, this equipment must be mounted in a suitable enclosure with proper wiring method for all power, input and output wiring that complies with the governing electrical codes and by the authority having jurisdiction over Class I, Division 2 installations.

Caution: To prevent the switch from overheating, ensure these minimum clearances:

- Top and bottom: 2.0 in. (50.8 mm)
- Exposed side: 1.0 in. (25.4 mm)
- Front: 2.0 in. (50.8 mm)

2.4 Installing the Switch on a DIN Rail

The switch ships with a spring-loaded latch on the rear panel to mount a DIN rail.

To attach the switch to a DIN rail, follow these steps:

1. Position the rear panel of the switch directly in front of the DIN rail, making sure that the DIN rail fits in the space between the two hooks near the top of the switch and the spring-loaded latch near the bottom.

2. Holding the bottom of the switch away from the DIN rail, place the two hooks on the back of the switch over the top

of the DIN rail.

Caution: Do not stack any equipment on the switch.

3. Push the switch toward the DIN rail to cause the spring-loaded latch at the bottom rear of the switch to move down and snap into place.

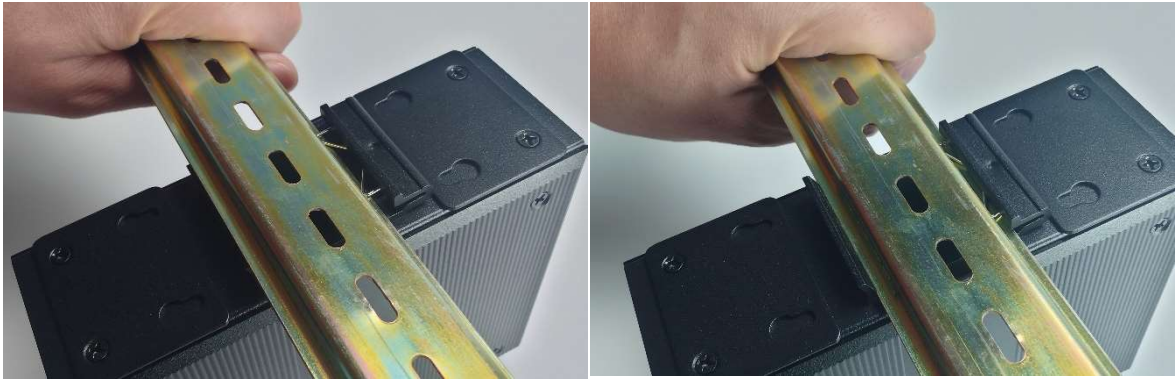

Figure 11 Steps of a switch mounted on DIN Rail

2.4.1 Installing the Switch on Wall

The switch ships with a pair of wall-mount kits on the rear panel for mounting on a wall.

To attach the switch to a wall, follow these steps:

1, When unpacking, the metal plate of the aluminium rail attachment has been fixed on the backside of the switch. Remove the wall-mounted metal plate from the switches and re-install it, as shown in the following figure.

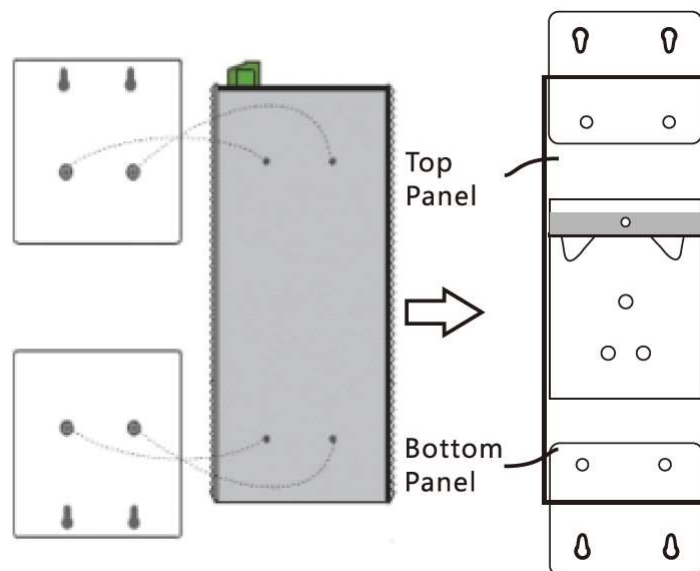

Figure 12 Preparing attach the switch onto the wall

2, Install the switch onto the wall. A total of 4 screws are required for wall mounting.

Notes: Before screwing the screws onto the wall, make sure that the screw size matches the wall-mounted metal panel

Caution: Do not stack any equipment on the switch.



Figure 13 Remove the wall-mounted metal plate from the switches and re-install

2.5 Connecting Alarm Circuits

Wiring the External Alarms

The switch has one alarm output relay circuit for external alarms. The alarm output relay circuit has a normally open and normally closed contact.

Alarm signals are connected to the switch through the 3-pin alarm connector. The three connections are for the alarm output circuit: an ordinarily open output, a normally closed output. An alarm output wiring connection is required to complete a single alarm output circuit.

Warning: Explosion Hazard—Do not connect or disconnect wiring while the field-side power is on; an electrical arc can occur. This could cause an explosion in hazardous location installations. Be sure that power is removed or that the area is nonhazardous before proceeding.

Caution: The input voltage source of the alarm output relay circuit must be an isolated source and limited to less than or equal to 24 VDC, 1.0 A or 48 VDC, 0.5 A.

To wire the switch to an external alarm device, follow these steps:

1. Remove the connector from the switch chassis.
2. Measure two strands of twisted-pair wire (16-to-18 AWG) long enough to connect to the external alarm device. Choose between setting up an external alarm input or output circuit.
3. Use a wire stripper to remove the casing from both ends of each wire to 0.25 inch (6.3 mm) \pm 0.02 inch (0.5 mm). Do not strip more than 0.27 inches (6.8 mm) of insulation from the wires. Stripping more than the recommended amount of wire can leave exposed wire from the alarm connector after installation.

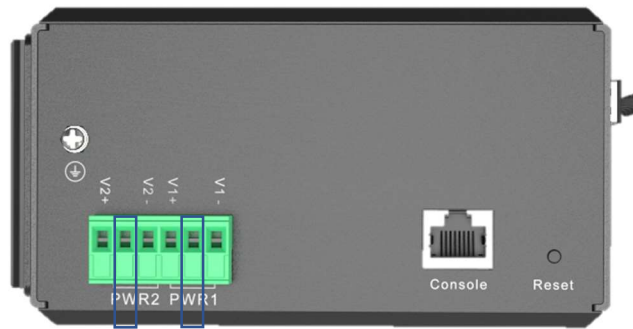

Figure 14 Alarm Connector

4. Insert the exposed wires for the external alarm device into the connections based on an alarm input or output circuit setup.
 5. Use a ratcheting torque flathead screwdriver to tighten the alarm connector captive screw (above the installed wire leads) to 2 in-lb (0.226 Nm.)
- Caution:** Do not over-torque the power and alarm connectors' captive screws. The torque should not exceed two in-lb (0.226 Nm).
6. Repeat Step 2 through Step 5 to insert the input and output wires of one additional external alarm device into the alarm connector.

2.6 Connecting Destination Ports

These sections provide more information about connecting to the destination ports:

- ❖ Linking to 10/100/1000 Lan Ports
- ❖ Installing and Removing SFP Modules
- ❖ Connecting to SFP Modules

2.6.1 Connecting to 10/100/1000 Lan Ports

The switch 10/100 ports automatically configure themselves to operate at the speed of attached devices. If the attached ports do not support auto-negotiation, you can explicitly set the speed and duplex parameters. Connecting devices that do not auto-negotiate or have their speed and duplex parameters manually set can reduce performance or result in no linkage.

To maximise performance, choose one of these methods for configuring the Ethernet ports:

- ❖ Let the ports auto-negotiate both speed and duplex.
- ❖ Set the port speed and duplex parameters on both ends of the connection.

The models that support PoE provide up to eight ports of PoE.

Caution: To prevent electrostatic discharge (ESD) damage, follow your regular board

and component handling procedures.

To connect to 10BASE-T, or 100BASE-T, or 1000BASE-T devices, follow these steps:

1. When connecting to workstations, servers, routers, and IP phones, connect a straight-through cable to an RJ-45 connector on the front panel.
2. Connect the other end of the cable to an RJ-45 connector on the other device. The port LED turns on when the switch and the connected device have established a link.

The port LED is amber while Spanning Tree Protocol (STP) discovers the topology and searches for loops. This can take up to 30 seconds, and the port LED turns green. If the port LED does not turn on:

- ❖ The device at the other end might not be turned on.
 - ❖ There might be a cable problem or a problem with the adapter installed in the attached device.
3. Reconfigure and reboot the connected device if necessary.
 4. Repeat Steps 1 through 3 to connect each device.

2.6.2 Installing and Removing SFP Modules

These sections describe how to install and remove SFP modules. SFP modules are inserted into SFP module slots on the front of the switch. These field-replaceable modules provide the uplink optical interfaces, send (TX) and receive (RX).

You can use any combination of rugged SFP modules. Each SFP module must be of the same type as the SFP module on the other end of the cable, and the line must not exceed the stipulated cable length for reliable communications.

For detailed instructions on installing, removing, and cabling the SFP module, see your SFP module documentation.

Warning: Do not insert and remove SFP modules while power is on; an electrical arc can occur. This could cause an explosion in hazardous location installations. Be sure that power is removed or the area is nonhazardous before proceeding.

2.6.3 Installing SFP Modules into SFP Module Slots

Caution: We strongly recommend that you do not install or remove the SFP module with fibre-optic cables attached to it because of the potential damage to the wires, the cable connector, or the optical interfaces in the SFP module. Disconnect all cables before removing or installing an SFP module.

Removing and installing an SFP module can shorten its useful life. Do not remove and insert SFP modules more often than is necessary.

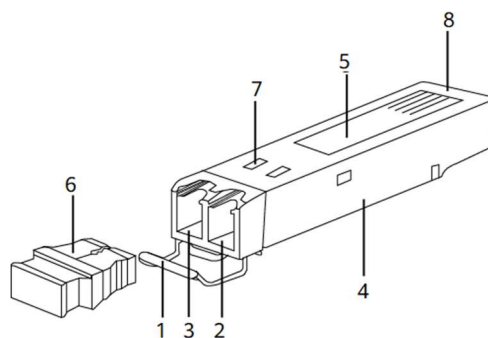

Figure 15 SFP Module Drawing

1	Handle	2	Receiver
3	Transmitter	4	Shell
5	Label	6	Dust Plug
7	Spring	8	Connector

To insert an SFP module into the SFP module slot:

1. Attach an ESD-preventive wrist strap to your wrist and a grounded bare metal surface.
2. Find the send (TX) and receive (RX) markings that identify the right side of the SFP module.

On some SFP modules, the send and receive (TX and RX) markings might be replaced by arrows that show the direction

of the connection, either send or receive (TX or RX).

3. Align the SFP module sideways in front of the slot opening.
4. Insert the SFP module into the slot until you feel the connector on the module snap into place in the rear of the space.
5. Remove the dust plugs from the SFP module optical ports and store them for later use.

Caution: Do not remove the dust plugs from the SFP module port or the rubber caps from the fibre-optic cable until you are ready to connect the cable. The pins and caps protect the SFP module ports and cables from contamination and ambient light.

6. Insert the LC cable connector into the SFP module.

2.6.4 Removing SFP Modules from SFP Module Slots

To remove an SFP module from a module receptacle:

1. Attach an ESD-preventive wrist strap to your wrist and a grounded bare metal surface.
2. Disconnect the LC from the SFP module.
3. Insert a dust plug into the optical ports of the SFP module to keep the optical interfaces clean.
4. Unlock and remove the SFP module.

If the module has a bale-clasp latch, pull the bale out and down to eject the module. If the bale-clasp latch is obstructed and you cannot use your index finger to open it, use a small, flat-blade screwdriver or other long, narrow instrument to open the bale-clasp latch.

5. Grasp the SFP module between your thumb and index finger, and carefully remove it from the module slot.
6. Place the removed SFP module in an antistatic bag or another protective environment.

2.6.5 Connecting to SFP Modules

This section describes how to connect to a fibre-optic SFP port. For instructions on how to install or remove an SFP module.

Warning: Class 1 laser product.

Warning: Do not connect or disconnect cables to the ports while power is applied to the switch or any device on the network because an electrical arc can occur. This could cause an explosion in hazardous location installations.

Be sure that power is removed from the switch and cannot be accidentally be turned on, or verify that the area is nonhazardous before proceeding.

Caution: Do not remove the rubber plugs from the SFP module port or the rubber caps from the fibre-optic cable until you are ready to connect the cable. The plugs and caps protect the SFP module ports and cables from contamination and ambient light.

Before connecting to the SFP module, be sure to understand the port and cabling guidelines in the Preparing for Installation.

To connect a fibre-optic cable to an SFP module, follow these steps:

1. Remove the dust plugs from the module port and fibre-optic cable, and store them for future use.
2. Insert one end of the fibre-optic cable into the SFP module port.

3. Insert the other cable end into a fibre-optic receptacle on a target device.
4. Observe the port status LED:
 - ❖ The LED turns green when the switch and the target device have an established link.
 - ❖ The LED turns amber while the STP discovers the network topology and searches for loops. This process takes about 30 seconds, and then the port LED turns green.
 - ❖ If the LED is off, the target device might not be turned on, there might be a cable problem, or there might be a problem with the adapter installed in the target device. See Troubleshooting.
5. If necessary, reconfigure and restart the switch or the target device.

2.7 Running Express Setup

If the default configuration is satisfactory, the switch does not need further configuration. You can use any of these management options to change the default configuration:

- ❖ Start Device Manager, which is in the switch memory, to manage individual and standalone switches. This is an easy-to-use web interface that offers quick configuration and monitoring. You can access Device Manager from anywhere in your network through a web browser. For more information, see the Express Setup section of the Device Manager online help.

Notes: FR-7N, FR-6N because it can't support Web-GUI management, so the following express setup procedure is not relative to this aspect.

When you first set up the switch, you should use Express Setup to enter the initial IP information. This process enables the switch to connect to local routers and the Internet. You can then access the switch through the IP address for additional configuration.

2.7.1 Required Equipment

You need this equipment to set up the switch:

- ❖ Computer with Windows 7/Windows 10/Mac
- ❖ Web browser (Microsoft Internet Explorer 11, Firefox 46.01 and 47.0, or Microsoft Edge 89.0) with JavaScript enabled. (Disable pop-up blockers and proxy settings and ensure that your browser uses the English EN-US language pack.)

Notes: Firmware upgrade may fail or never complete when initiated using a browser language pack other

than en-US.

- ❖ A straight-through or crossover Category 5 Ethernet cable connects your computer to the switch port.
- ❖ A small paper clip to reach the express setup button.

Notes: Before running Express Setup, disable any wireless client running on your computer.

2.7.2 Express Setup Procedure

To run Express Setup:

1. Make sure that nothing is connected to the switch.
2. Connect power to the switch.
3. Power on or reset the switch:
 - ❖ Use LEDs to monitor boot progress

Sys Blank: POST

Sys solid: exit post, initialising

Sys and alarm LEDs green: init done

~25 seconds after power-on

4. Ensure the switch is in default factory mode.

Skip to the next step if freshly out of the box

- a. If not freshly out of the package, use a paper clip to reset the switch by depressing the express setup button for 15 - 20 seconds
 - b. Switch will automatically reboot
5. Ensure no data port is connected to the switch.

Note: During Express Setup, the switch acts as a DHCP server.

- ❖ Ensure the computer connected to the switch is configured to receive an IP address from the DHCP server.
6. Insert a paper clip into the express setup button for 1-2 seconds
 - ❖ When released, EXP LED starts flashing green.
 7. Connect the computer to port Fa 1/1; LED continues to blink
 8. Ensure the computer has received the IP Address 192.168.1.1,
 9. Point browser to <http://192.168.1.254>

10. Leave the username blank and enter the default password

a. Troubleshooting: If the Express Setup window does not appear, make sure that any pop-up blockers or proxy settings on your browser are disabled and that any wireless client is disabled on your computer.

11. Enter all entries in English letters and Arabic numbers.

In the Network Settings (Required for Static IP):

- ❖ New Admin User: Password must be eight characters long, contain upper and lower case characters, a number and a symbol (!@#\$%^).
- ❖ IP Address: Enter a valid IP address for the switch.

Later, you can use the IP address to access the switch through Device Manager.

- ❖ (Optional) Default Gateway: Enter the IP address of the router.

Notes: The Device manager will not allow you to exit the express setup page if the static IP address of the switch and the Default Gateway is not in the same subnet.

12. Optional Settings

You can enter the optional information or enter it later by using Device Manager. For more details on the Express Setup fields, see the online help for the Express Setup window.

Click Submit to save your changes and to complete the initial setup.

For more information about the optional settings, click Help on the toolbar.

13. After you click Submit, these events occur:

- a. The switch is configured and exits Express Setup mode.
- b. The browser displays a warning message, instructing the user to clear browser cookies.
- c. Typically, connectivity between the computer and the switch is lost because the configured switch IP address is in a different subnet from the IP address on the computer.
- d. If you changed the Management Interface Vlan ID, then after pressing submit, all Ethernet interfaces on the switch are now members of this new VLAN. This is to enable the connection to the network.

14. Remove the PC and connect the switch to the network as configured in step 12.

Notes: After power cycling, the switch will not act as a DHCP server. DHCP Server behaviour is unique to Express Setup. to reconnect to the Switch after the power cycle, you will need to A) configure a static IP Address on your PC that is in the same subnet as the IP Address you just assigned, or B) connect to the new IP Address of the Switch from the network.

15. You can now manage the switch by using the Device Manager for information about configuring and managing the switch.

You can display Device Manager by following these steps:

- a.** Start a web browser on your computer.
- b.** Enter the switch IP address, username, and password in the web browser, and press Enter. The Device Manager page appears.



Chapter 3 Troubleshooting and Maintenance

This Chapter provides these topics for troubleshooting problems:

- ❖ Diagnosing Problem
 - ❖ The Switch Serial Number
 - ❖ Cable and Connectors
-

If the Device Manager page does not appear:

- ❖ Ping the device's IP address from the PC where the browser is launched. If not, check Computer's network connectivity.
- ❖ Confirm that the port LED for the switch port connected to your network is green.
- ❖ Confirm that the computer that you are using to access the switch has network connectivity by clicking it to a well-known web server in your network. If there is no network connection, troubleshoot the network settings on the computer.
- ❖ Make sure that the switch IP address in the browser is correct.
- ❖ If the switch IP address in the browser is valid, the switch port LED is green, and the computer has network connectivity, continue troubleshooting by reconnecting the laptop to the switch. Configure a static IP address on the computer in the same subnet as the switch IP address.
- ❖ When the LED on the switch port connected to the computer is green, reenter the switch IP address in a web browser to display the Device Manager. When Device Manager appears, you can continue with the switch configuration.

3 Troubleshooting

3.1 Diagnosing Problem

The switch LEDs provide troubleshooting information about the switch. They show fast boot failures, port-connectivity problems, and overall switch performance. You can also get statistics from Device Manager.

3.1.1 Switch LEDs

Look at the port LEDs information when troubleshooting the switch. See LEDs, page 6, for a description of the LED colours and their meanings.

3.2 Switch Connections

3.2.1 Bad or Damaged Cable

Always examine the cable for marginal damage or failure. A cable might be just good enough to connect at the physical layer, but it could corrupt packets due to slight damage to the wiring or connectors. You can identify this problem because the port has many packet errors or constantly flaps (loses and regains link).

- ❖ Exchange the copper or fibre-optic cable with a known suitable cable.
- ❖ Look for broken or missing pins on cable connectors.
- ❖ Rule out any bad patch panel connections or media convertors between the source and the destination. If possible, bypass the patch panel, or eliminate media convertors (fibre-optic-to-copper).
- ❖ Try the cable in another port to see if the problem follows the line.

3.2.2 Ethernet and Fiber-Optic Cables

Make sure that you have the correct cable:

- ❖ For Ethernet, use Category 3 copper cable for 10 Mb/s UTP connections. Use either Category 5, Category 5e, or Category 6 UTP for 10/100 Mb/s, and PoE connections.
- ❖ Verify that you have the correct fibre-optic cable for the distance and port type. Make sure that the connected device ports match and use the same type encoding, optical frequency, and fibre type.
- ❖ Determine if a copper crossover cable was used when a straight-through was required or the reverse.

3.3. Link Status

Verify that both sides have a link. A broken wire or a shutdown port can cause one side to show a link even though the other side does not have a connection.

A port LED that is on does not guarantee that the cable is functional. It might have encountered physical stress, causing it to function at a marginal level. If the port LED does not turn on:

- ❖ Connect the cable from the switch to a known suitable device.
- ❖ Ensure that both ends of the line are connected to the correct ports.
- ❖ Verify that both devices have power.
- ❖ Verify that you are using the correct cable type. See Cables and Adapters, page 38 for information.
- ❖ Look for loose connections. Sometimes a cable appears to be seated but is not. Disconnect the line, and then reconnect it.

3.4 10/100/1000 Lan Port Connections

If a port appears to malfunction:

- ❖ Verify the status of all ports by checking the LEDs.
- ❖ Verify the cable type.

3.5 SFP Module

Use only Fiberroad SFP modules. Each Fiberroad module has an internal serial EEPROM encoded with security information.

This encoding verifies that the module meets the requirements for the switch.

- ❖ Inspect the SFP module. Exchange the suspect module with a known suitable module.
- ❖ Verify that the module is supported on this platform. (The switch release notes on Fiberroad list the SFP modules that the switch supports.)
- ❖ Make sure that all fibre-optic connections are clean and securely connected.

3.6 Interface Settings

Verify that the interface is not disabled or powered off. If an interface is manually shut down on either side of the link, it does not come up until you reenables the interface. If needed, reenables the interface.

3.7 Ping End Device

Ping from a laptop first, and then work your way backport by port, interface by the interface, trunk by trunk until you find the source of the connectivity issue. Make sure that each switch can identify the end device MAC address in its Content-Addressable Memory (CAM) table.

3.8 Spanning Tree Loops

STP loops can cause serious performance issues like port or interface problems.

A unidirectional link can cause loops. It occurs when the traffic sent by the switch is received by the neighbour, but the traffic from the neighbour is not received by the switch. A broken cable, other cabling problems, or a port issue can cause

this one-way communication.

3.9 Switch Performance

Speed, Duplex, and Autonegotiation

Port statistics that show many alignment errors, frame check sequence (FCS), or late-collisions errors might mean a speed or duplex mismatch.

A common issue occurs when duplex and speed settings are mismatched between two switches, between a button and a router, or between a workstation or server. Mismatches can happen when manually setting the speed and duplex or from auto-negotiation issues between the two devices.

To maximise switch performance and ensure a link, follow one of these guidelines when changing the duplex or the speed settings.

- ❖ Let both ports autonegotiate both speed and duplex.
- ❖ Manually set the speed and duplex parameters for the interfaces on both ends of the connection.
- ❖ If a remote device does not autonegotiate, use the same duplex settings on the two ports. The speed parameter adjusts itself even if the connected port does not autonegotiate.

3.9.1 Autonegotiation and Network Interface Cards

Problems sometimes occur between the switch and third-party network interface cards (NICs). By default, the switch ports and interfaces auto-negotiate. Laptops or other devices are commonly set to auto-negotiate, yet sometimes issues occur.

To troubleshoot auto-negotiation problems, try manually setting both sides of the connection. If this does not solve the problem, there could be a problem with the firmware or software on the NIC. You can resolve this by upgrading the NIC driver to the latest version.

3.9.2 Cabling Distance

If the port statistics show excessive FCS, late-collision, or alignment errors, verify that the cable distance from the switch to the connected device meets the recommended guidelines.

3.10 Resetting the Switch

These are reasons why you might want to reset the switch to the factory default settings:

- ❖ You installed the switch in your network and cannot connect because you assigned the wrong IP address.
- ❖ You want to reset the password on the switch.

Notes: Resetting the switch deletes the configuration and reboots the switch.

To reset the switch:

1. Press and hold the Express Setup button (recessed behind a small hole in the faceplate) for about 15-20 seconds with a paper clip or similar object. The switch reboots. The system LED turns green after the switch completes rebooting.
2. Press the Express Setup button again for 3 seconds. Fa 1/1 port blinks green.

The switch now behaves like an unconfigured switch.

3.11 The Switch Serial Number

If you contact Fiberroad Technical Assistance or post-sales services, you need to know the serial number of your switch; The serial number is on the bottom.

3.12 Cable and Connectors

3.12.1 Connector Specifications

3.12.2 10/100/1000 Lan Ports

The 10/100 Ethernet ports on the switches use RJ-45 connectors

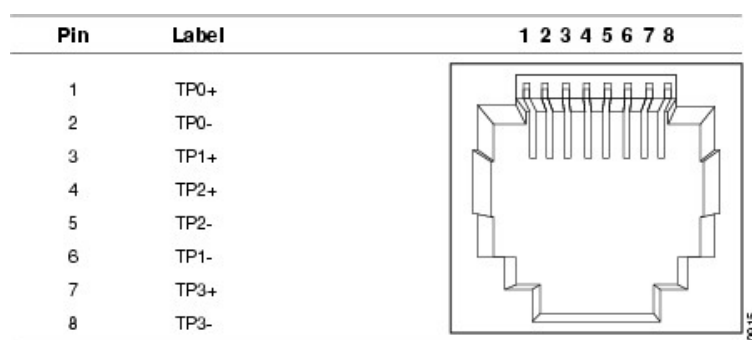

Figure 16 10/100/1000 Lan Port Pinouts

Notes: For the two models of the switch that support PoE, connector pins 4 and 5 supply +48VDC and pins 7 and 8 are the DC voltage return lines.

Caution: PoE faults are caused when non-compliant cabling or powered devices are connected to a PoE port. Only standard-compliant cabling can be used to connect pre-standard IP phones, IP cameras or wireless access points or IEEE 802.3af-compliant devices to PoE ports. A cable or device that cause a PoE fault must be removed from the network.

Notes: You can use the MDIX auto interface configuration command via CLI or WebGUI to enable the automatic medium-dependent interface crossover(Auto-MDIX) feature. When the Auto-MDIX feature is enabled, the switch detects the required cable type for copper Ethernet and configures the interfaces accordingly. Therefore, you can use either a crossover or straight-through actions to a copper 10/100, 10/100/1000 or 1000BASE-T SFP module port on the switch, regardless of the type of device on the other end the connection.

3.12.3 Fiber- Optic Module Connectors

Figure 17 Fiber-Optic Module Connectors show LC, SC, ST, FC type connectors used with Fiber-Optic Module. It's a fibre-optic cable connector.



Figure 17 Fiber-Optic Module LC, SC, FC, ST connectors

Warning: Invisible laser radiation may be emitted from disconnected fibres or connectors. Do not stare into beams or view directly with optical instruments.

3.12.4 Console Port

The console port uses an 8-pin RJ-45 connector, described in Table A-1 and Table A-2. The supplied RJ-45 to DB9 adapter cable connects the switch's console port to a console PC. You need to provide an RJ45 to DB25 female DTE adapter to connect the switch console port to a terminal.

Switch Console Port(DTE)	RJ45 To DB9 Terminal Adapter	Console Device
Signal	DB9 Pin	Signal
RTS	8	CTS
DTR	6	DSR
TxD	2	RxD
GND	5	GND
GND	5	GND
RxD	3	TxD
DSR	4	DTR
CTS	7	RTS

Table A-1 Console Port Signaling Using a DB-9 Adapter

Switch Console Port(DTE)	RJ45 To DB25 Terminal Adapter	Console Device
Signal	DB9 Pin	Signal
RTS	5	CTS
DTR	6	DSR
TxD	3	RxD
GND	7	GND
GND	7	GND
RxD	2	TxD
DSR	20	DTR
CTS	4	RTS

Table A-2 Console Port Signaling Using a DB-25 Adapter

3.13 Fiber-Optic Module Cables

Each port must match the wave-length specifications on each end of the cable, and for reliable communications, the cable must not exceed the allowable length.

Notes

- ❖ The maximum operating temperature of the switch varies depending on the type of SFP module you use.
- ❖ Modal bandwidth applies only to multimode fibre.
- ❖ A mode-field diameter/cladding diameter = 9 micrometers/125 micrometers.
- ❖ A mode-conditioning patch cord is required when using 1000BASE-LX/LH SFP modules, MMF, and a short link distance. An ordinary patch cord can cause transceiver saturation, resulting in an elevated bit error rate (BER). When using the LX/LH SFP module with 62.5-micron diameter MMF, you must install a mode-conditioning patch cord between the SFP module and the MMF cable on both the sending and receiving ends of the link. The mode-conditioning patch cord is required for connection distances greater than 984 feet (300 m).
- ❖ 1000BASE-ZX SFP modules can send data up to 62 miles (100 km) using dispersion-shifted SMF or low-attenuation SMF. The distance depends on the fibre quality, the number of splices, and the connectors.
- ❖ When the fibre-optic cable span is less than 15.43 miles (25 km), insert a 5-decibel (dB) or 10-dB inline optical attenuator between the fibre-optic cable plant and the receiving port on the 1000BASE-ZX SFP module.

The information in this document is subject to change without notice. Fiberroad has made all effects to ensure the accuracy of the information, but all information in this document does not constitute any kind of warranty. If you have any questions, please feel free to contact to us.

Fiberroad Technology Co., Ltd

www.fiberroad.com

Sales Support: sales@fiberroad.com

Technical Support: tech@fiberroad.com

Service Support: service@fiberroad.com

